



AMAZONE

Trailed fertiliser spreader **ZG-TS**

Trailed bulk spreader **ZG-B**



AMAZONE
spreaders meet all
European environ-
mental standards

ZG-TS and ZG-B trailed fertiliser spreaders

Perfectly matched to your needs!



Uniform plant growth is the most important requirement for producing high yields. No single location can offer plants uniform growing conditions across the whole field. To ensure that plants receive balanced nutrition, the application of mineral fertilisers must therefore always be adapted to the individual requirements. The decisive factor for maximising fertiliser efficacy is therefore not only the selection of the optimum fertiliser, but also, and most importantly, the careful and precise distribution of those nutrients.

ZG-TS

The professional mineral fertiliser spreader

Model	Hopper capacity
ZG-TS 7501	7,500 l
ZG-TS 10001	10,000 l

ZG-TS Truck

The spreader body for carrier vehicles

Model	Hopper capacity
ZG-TS Truck 7501	7,500 l
ZG-TS Truck 10001	10,000 l

ZG-B

The all-rounder

Model	Hopper capacity
ZG-B 5500	5,500 l
ZG-B 8200	8,200 l

Precisely fertilised, more yield

	Page
ZG-TS The advantages at a glance	4
ZG-TS Overview	6
ZG-TS High-quality, multi-layer paint finish	8
ZG-TS Hopper	10
ZG-TS Steering Braking force compensation	12
ZG-TS ProfisPro weighing system	14
ZG-TS Intelligent fill level management	16
ZG-TS Spreading disc drive options	18
ZG-TS Soft Ballistic System pro	20
ZG-TS Spreading system	22
ZG-TS TS spreading discs Normal spreading	26
ZG-TS AutoTS border spreading system	28
ZG-TS BorderTS border spreading process	32
ZG-TS Innovation Farm field trials	34
ZG-TS HeadlandControl	36
ZG-TS WindControl	38
ZG-TS ArgusTwin	40
ZG-TS Equipment	42
ZG-TS ZG-TS/ZG-B Truck demount spreader	44
ZG-TS ISOBUS	46
ZG-TS GPS ScenarioControl	54

ZG-B The advantages at a glance	56
ZG-B Overview	58
ZG-B ZG-B Special ZG-B Super	60
ZG-B Spreading system Limiter border spreading system	62
ZG-B Equipment	64
Spreader Application Center mySpreader App	66
AMAZONE service	68
Technical data	70

ZG-TS trailed spreader



15 m – 54 m



7,500 l and 10,000 l



128 part-width sections



Fertiliser, pelleted materials,
seeds, slug pellets

The advantages at a glance:

- + Efficient and intelligent**
Precise spread patterns with working widths of up to 54 m and application rates of 650 kg/min
- + ProfisPro – spread rate calibration**
Absolutely accurate application rates from the very first second irrespective of which side
- + WindControl**
Windless conditions at the touch of a button – compensation for the effects of the wind on the lateral distribution
- + ArgusTwin – spread fan monitoring**
Permanent monitoring – optimum lateral distribution under any conditions
- + HeadlandControl – headland optimisation**
Uniform crops across the headland – optimised parabolic Section Control
- + AutoTS and BorderTS – border spreading systems**
Proven precision – maximum yield at the field boundaries

MORE INFORMATION

www.amazone.net/zg-ts



PRODUCT FILM
Find out more



DOWNLOADS
mySpreader App



SMARTLEARNING
www.amazone.net/smartlearning

ZG-TS – the benchmark for precision



Fertiliser can be spread without problem with WindControl, even in windy regions

! “Precise and stylish!”

(“profi” – Test report ZG-TS 01 ProfisPro · 06/2018)

The ZG-TS trailed spreader, in hopper capacities of either 7,500 l or 10,000 l and capable of working widths of up to 54 m and operational speeds of up to 30 km/h, provides the means for maximum outputs. The integrated AutoTS border spreading system and GPS-Switch automatic part-width section control of up to 128 part-width sections allows for very precise spreading results. The on-line ProfisPro weighing system ensures the continuous monitoring of the application rate, and the ArgusTwin monitors the pattern for the perfect lateral distribution even with changeable fertiliser or adverse weather conditions. The WindControl system means longer operating windows and an optimised lateral distribution even in windy conditions.

Multiple awards – Spreads success – Reaps recognition

ArgusTwin:

the eyes of the spreader.
Automatic spread pattern monitoring



Gold
Agritechnica

WindControl system:

in accordance with Prof. Dr. Karl Wild HTW
Dresden



Silver
Agritechnica

HeadlandControl:

Optimum lateral distribution on the
headland



Silver
Agritechnica

EasyCheck:

The digital and mobile calibration kit



Silver
Agritechnica

EasyMix:

The App for easy adjustment and evaluation of blended fertilisers



Silver
Agritechnica

With its combination of shape and performance, ZG-TS 10001 convinced and inspired the iF Jury, consisting of experts and designers from all over the world. The jury's evaluation criteria included, in addition to the quality of design, the finish and material choice, the degree of innovation and the environmental compatibility, its functionality and ergonomics and, finally, a visualisation of use and safety.



The best of both worlds

Cathodic dip painting (CDP) combined with powder coating

7 years
guarantee

against perforation corrosion



register
enregistrer
registrieren



The new painting technique, in combination with a large proportion of stainless steel components ensures a high level of operational reliability and a long service life.



The KTL dip-paint priming of all components ensures virtually full-area corrosion protection.



Double protection through the additional thick powder coating, providing increased protection against mechanical wear and tear.

High-quality, multi-layer paint

The paintwork on a fertiliser spreader is exposed to particular demands. The paintwork is intended to protect the spreader from corrosion, especially when handling fertiliser and where moisture is involved. Starting with the 2022 model year, a new painting process is used for the ZA-V, ZA-TS and ZG-TS fertiliser spreader ranges. This involves, on the one hand, a cathodic dip painting process (known as KTL) for priming to give the best possible protection on the internal surfaces of tubes and box sections and, on the other hand, a powder coating process to create a high-quality visual finish with extra-thick paint providing increased protection against mechanical demands.

7 year manufacturer's guarantee

Based on this optimum painting process, AMAZONE is able to offer its customers a manufacturer guarantee of seven years against rusting through. From 01/01/2023, customers can apply to have the guarantee activated for ZA-V, ZA-TS, and ZG-TS models, starting from the 2022 model year. This registration is done very simply via the manufacturer's

portal, myAmazone, bearing in mind the terms and conditions (www.amazone.net/7-years) stated there. After registration, one can continue to work without any worries.

The benefits

- ✔ **Cathodic dip painting process**
 - Suppression of rust infiltration
 - Best possible protection, even on the inner surfaces of tubes and box sections
- ✔ **Powder coated topcoat**
 - Double protection through additionally applied powder coating
 - Improved resistance against everyday wear and tear
- ✔ **Quality and reliability**
 - All the components on the spreading unit and all the hydraulic fittings are made of stainless steel
 - Impact, UV and chemical resistant plastic sieves

High-quality, multi-layer paint finish - the most modern from all angles:

- ① 14-stage **painting preparation** (e.g. degreasing)
- ② **Zinc phosphating** provides the most effective counteraction of rust formation
- ③ **Thick cathodic dip priming** for full corrosion protection, even in cavities and those hard-to-reach areas
- ④ **Powder coating** for a high-quality appearance and extra thick paint for increased protection against mechanical demands



The combination of tried and tested painting techniques brings together the best from all areas, resulting in a high-quality, multi-layer paint finish

Intelligent design

No compromise on functionality and capacity

Accurate metering

After the pre-chamber, the fertiliser is metered by means of the shutter slides in the exactly the same way as on the mounted spreaders.

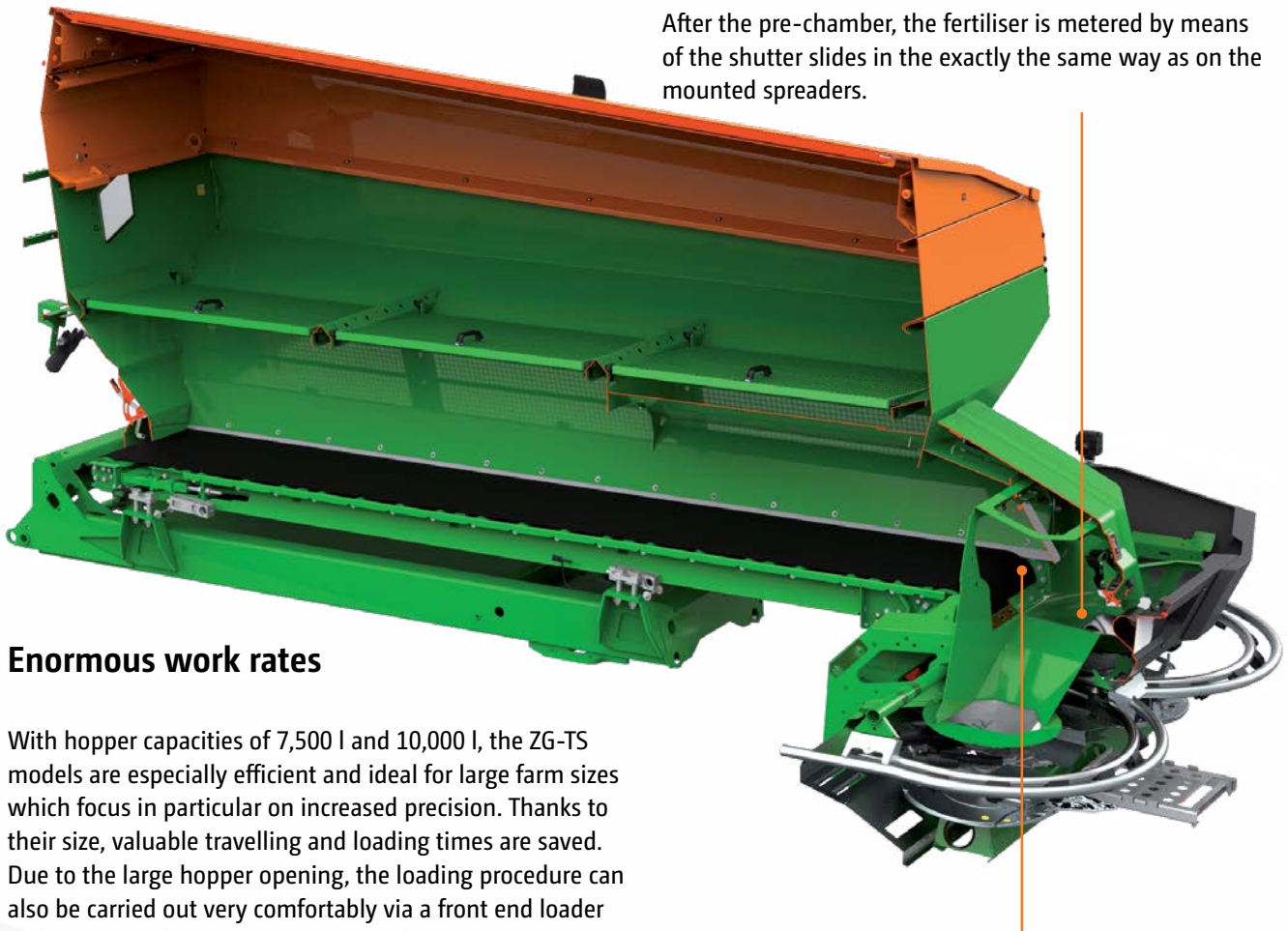

Enormous work rates

With hopper capacities of 7,500 l and 10,000 l, the ZG-TS models are especially efficient and ideal for large farm sizes which focus in particular on increased precision. Thanks to their size, valuable travelling and loading times are saved. Due to the large hopper opening, the loading procedure can also be carried out very comfortably via a front end loader or from a bulk filling system. The belt floor, automatically centred to the middle, ensures the optimum material flow.

Automatic pre-chamber filling

An endless this automatically fills the pre-chamber during the spreading operation.

Benefits of the base hopper

- ✔ Low hopper centre of gravity
- ✔ Low filling height
- ✔ Large fill opening
- ✔ Low wear rubber floor belt
- ✔ Automatic belt floor centralisation

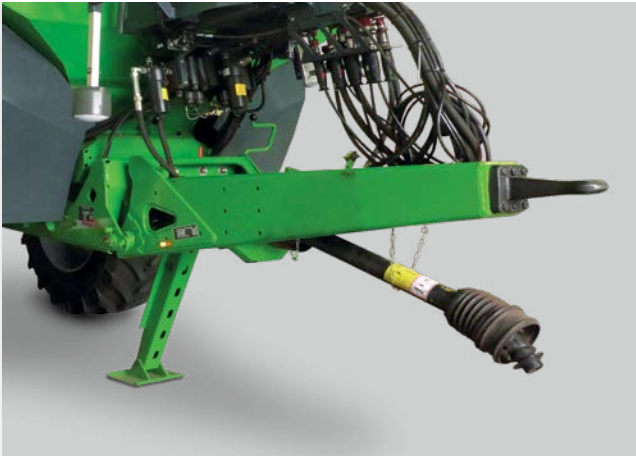

✔ Clevis type coupling with towing eye



✔ Hitch coupling with K80 ball coupling

Drawbar – couple up and go!

Make the choice that suits your tractor! The drawbar and coupling system are freely combinable. Decide between a towing eye, a K80 ball coupling, a ring coupling or a

pivoting ring coupling and select between a drawbar hitch coupling and the classic drawbar coupling!

Everything flows smoothly thanks to the optimum hopper shape

Thanks to the sophisticated hopper shape of the ZG-TS, it has an optimum centre of gravity which significantly counteracts any negative support loads. The steep hopper walls without corners or edges ensure the optimum flow of material, even in sloping terrain. This also makes the cleaning process considerably easier. In addition, there is also an increased range of movement for the steering axle which has steering angles of up to 28 °.

Benefits of the hopper design

- ✔ Optimum material flow even in sloping terrain
- ✔ Simple cleaning procedure
- ✔ Generous space for the axle steering
- ✔ Sophisticated centre of gravity avoids any negative support loads
- ✔ High ground clearance



Model	Hopper capacity	Unladen weight	Payload
ZG-TS 7501	7,500 l	3,850 kg	8,650 kg
ZG-TS 10001	10,000 l	4,000 kg	8,500 kg

Manoeuvrable and comfortable

Perfect driving behaviour on the road and in the field



60 km/h

- ❗ "The axle steering is new for the fertiliser spreaders [...] This makes the machines manoeuvrable and enables true-track following."

("profi" – Test report ZG-TS 01 ProfisPro · 06/2018)

Greater comfort – gentle on the crop

- ✔ True track-following at track widths of 1.80 to 2.25 m
- ✔ Increased driving comfort due to sprung-suspended and height adjustable drawbar system
- ✔ Stable and robust chassis technology, designed for speeds of up to 60 km/h
- ✔ Automatic braking force control
- ✔ Oversized tyres reduce the ground pressure and allows operation even under the most arduous of conditions
- ✔ Wheel diameters of up to 2.05 m possible



Steering axle with a steering angle up to 28°



Braking force control via electronic braking system (EBS)

True-track axle steering

The ZG-TS trailed spreaders, equipped with the optional steering axle, provides a maximum steering angle of up to 28°. This means: true track-following is still possible even with a track width of 1,800 mm and a tyre width of 520 mm. The automatic steering even allows counter-steering on slopes. As soon as the spreading disc drive has been deactivated and a speed of 15 km/h is exceeded, the steering automatically stops to ensure the safe road transport at speeds of up to 60 km/h.

Benefits of axle steering

- ✔ Steering angle up to 28°
- ✔ Minimum turning radius of 4.5 m
- ✔ True track-following – for gentle crop treatment
- ✔ Counter-steering in sloping terrain

Automatic braking force control

In order to be safe on the road, even at high speeds and different load capacities, the ZG-TS offers an optional automatic load-dependent braking force control. The electronic braking system (EBS) receives the signal for determining the load-dependent braking force from the Profis on-line weighing system. Since the weighing system continuously determines the quantity in the hopper, the delivered braking force adapts automatically. Due to this, the braking sensitivity is perfect for all load ranges. The ZG-TS also fulfils the requirements of the EU braking regulations 167/2013.

Advantages of the electronically-controlled braking system

- ✔ Load-dependent braking
- ✔ Comfortable and safe road travel
- ✔ Maximum safety on the headlands and on slopes

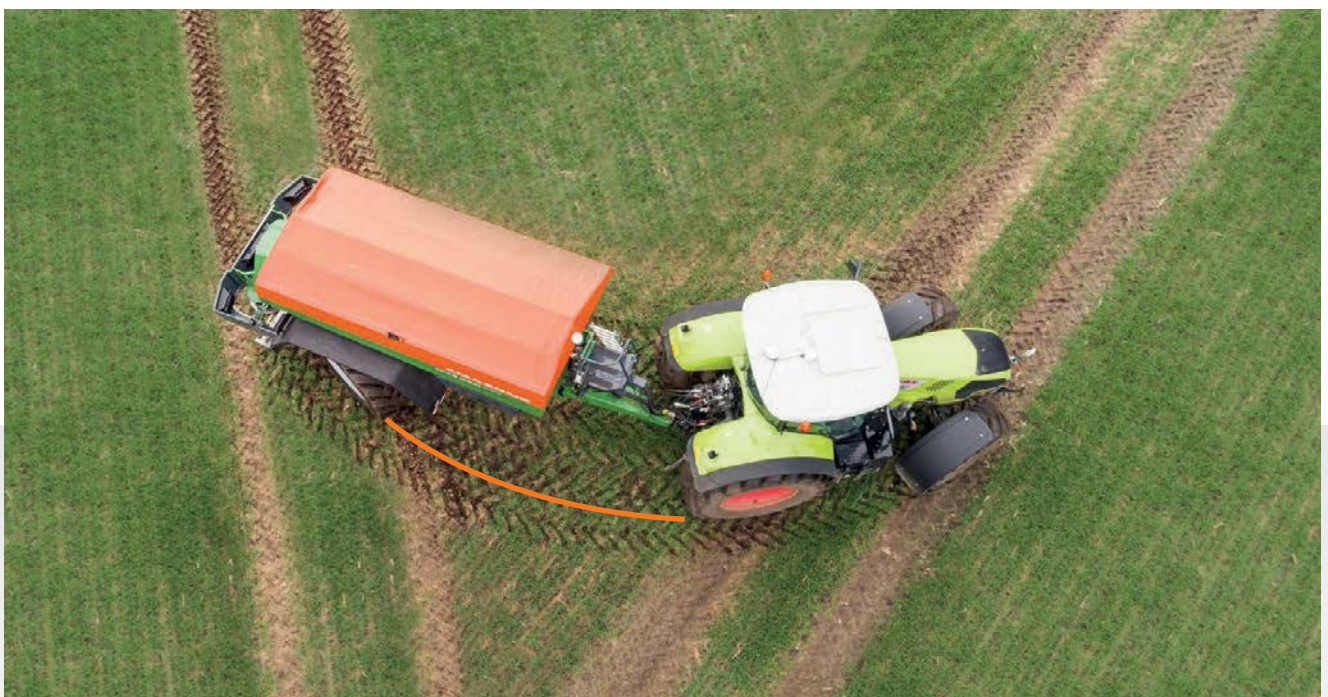

Exclusive!

ProfisPro weighing system with torque measuring system

The ProfisPro intelligent weighing system combines the benefits of the weighing system with the FlowControl torque measuring system

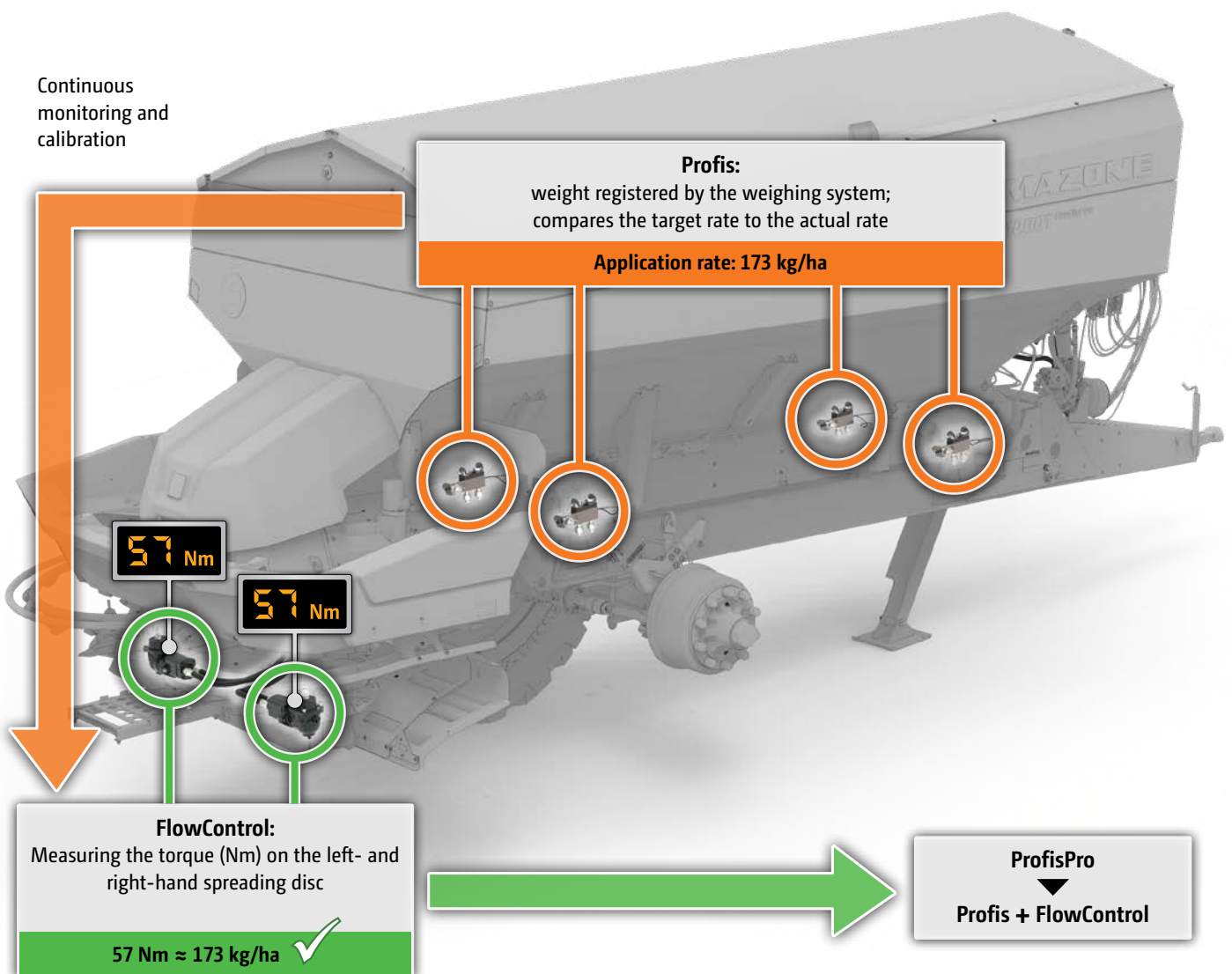

ProfisPro

The spread rate regulation, controlled between the Profis weighing system and the FlowControl sensors, is a unique selling feature for AMAZONE.



Profis – intelligent weighing system

The hopper and its frame are connected to a separate chassis via four 200 Hz weigh cells in the Profis weighing system which is integrated in the frame. Thus, there are no weight measuring points which are influenced by the traction forces of the tractor. Precise online weighing every 25 kg is the result!

A tilt sensor is fitted as standard to additionally compensate for the inclination of the machine on slopes. The signal is simultaneously used to counter-steer on slopes via the steering axle. This prevents the ZG-TS from drifting.

FlowControl – torque measuring system

The FlowControl torque measuring system reliably monitors the torque on each spreading disc drive from the very first second and can adjust the position of each spread rate shutter in the event of a deviation from the target rate irrespective of the side.

The applied rate is precisely documented for a field-related nutrient balance. In addition, the application rate can be altered at any time by pressing a button on the ISOBUS terminal.

Optimised spread rate from the very first second

This combination of the Profis weighing system and FlowControl enables the fertiliser spreader to use torque to regulate its theoretical application rate throughout the complete spreading process. The Profis weighing system monitors the actual spread rate every 25 kg. This allows FlowControl to recalibrate itself at regular intervals. This takes place without any need to stop. The ProfisPro intelligent weighing system means that the spread rate is optimised from the very first second of the spreading process. In addition, the driver has an overview of the actual quantity remaining in the hopper at all times as well as the possibility to display the remaining distance to travel until empty.

The benefits

Accurate weight measurement:

- ✔ display of residual volume
- ✔ Remaining area and residual hopper contents display
- ✔ Documentation of the total amount spread

Regulating/calibrating under all operating conditions:

- ✔ Side-independent rate calibration
- ✔ Absolute accuracy from the very first second
- ✔ Detection of travelling empty and any blockages
- ✔ Double security as a result of mutual monitoring of both systems

Intelligent technology

- ✔ Control of the steering axle on slopes
- ✔ Comfortable on the road thanks to load-dependent braking force regulation

Intelligent fill level management

Your reliable assistant!



Intelligent fill level management

The extremely clever Profis weighing system goes into action with its intelligent fill level management right from the loading stage. Without the use of an external scale, the system gives precise information about the load condition at all times, thus preventing overloading and empty travelling. Profis also sets standards as a filling aid as well as through the continuous measurement of the hopper contents.

The benefits

- ✔ Intelligent filling aid
- ✔ Reliable fill level measurements even without using an external weighing system
- ✔ Avoidance of unnecessary empty travelling and excessive residues

- ✔ The filling process can be optimally monitored from the large, easily accessible platform.





✔ Filling by just one person, very simple!



✔ If the work light illuminate constantly, the desired fill level has been reached

Filling aid

Operators will particularly love the filling aid provided by the work lights and the Profis weighing system. Initial flashing followed by the constant lighting up of the work lights signals that the fill level has been reached. A second person, or the frequent dismounting for checking, are no longer necessary.

❗ “Via flashing signals the work lights [...] inform the driver of the filling vehicle as to the quantity filled – so a precise filling is possible“

(“profi“– Test report ZG-TS 01 ProfisPro · 06/2018)

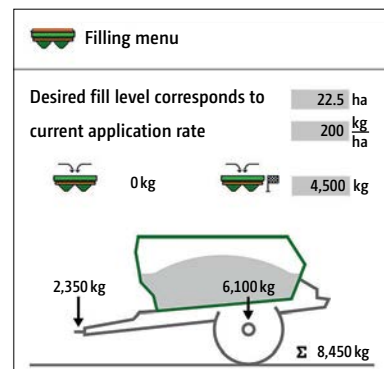

Filling menu – determination of the desired fill level

Optimum load distribution under all spreading conditions

Thanks to the real time measuring via the Profis weighing system, the axle and support loads can be optimally utilised during the filling procedure. This is because during the filling procedure it is possible to see where the load is concentrated and thus prevent either the overloading of the axle or the drawbar.

Furthermore, the floor belt rises by 5 degrees which enables a transfer from the back to the front. This guarantees optimum load distribution during spreading. Maximum drawbar load and reduced axle loads enable safe driving in the field under all operating conditions.

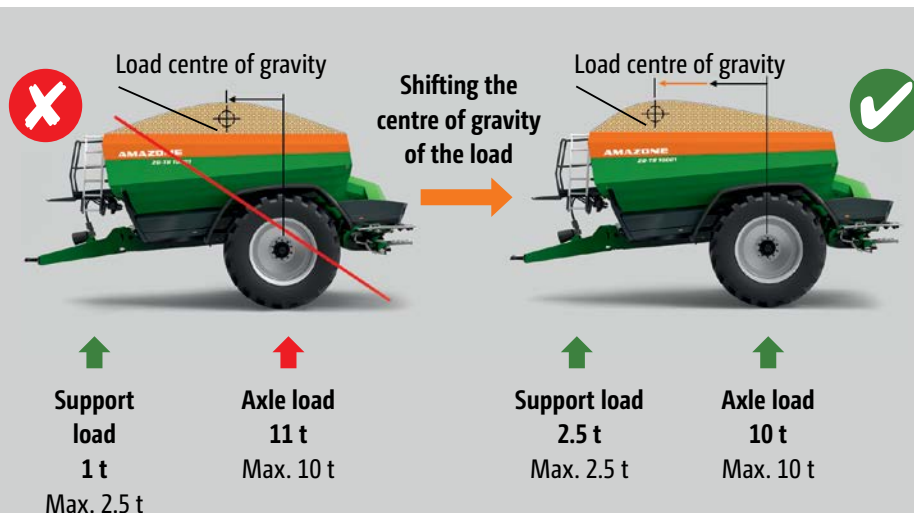

Spreading technology that is well thought through

Benefit from more than 100 years of experience

Hydraulic spreading disc drive

The Hydro version makes operation possible irrespective of the tractor's engine revs and with different spreading disc speeds. In this way, fuel consumption is reduced and a particularly comfortable and precise spreading is ensured. The spreader also operates at various different spreading disc speeds when border spreading, so that the best-possible lateral distribution can be achieved in the overlap area and to the field boundary.

The benefits

- ✔ The side-independent regulation of the spreading disc speed permits even more precise spreading on wedge-shaped fields. Up to 128 part-width sections are possible in combination with SectionControl.
- ✔ In combination with WindControl, side-independent regulation enables windy conditions to be compensated for
- ✔ Pressure filter as standard



Hydraulic disc drive

The drive options

Suited to any tractor size

Hydro drive – the drive with Load-Sensing system

Spreaders with Hydro drive are fully supplied via the Load-Sensing system of the tractor. For tractors with sufficient oil supply, the ISOBUS connecting cable is sufficient and the Load-Sensing system can operate the spreader at full functionality.

- ✔ Change between load sensing and an oil flow and return as standard



Hydro drive with oil supply exclusively from the tractor

- Oil requirement with steering axle max. 130 l/min
- Oil requirement without steering axle max. 105 l/min

Hybrid drive – maximum efficiency, even on smaller tractors

For spreaders with hybrid drive, approximately two thirds of the oil capacity come from the Load-Sensing system of the tractor and the other third is reused with the aid of a second pump in the return-flow to the tractor. For this, a hydraulic pump is driven directly via the tractor's power take off shaft. This hybrid system allows the use of smaller tractors and is, at the same time, significantly lower priced than a normal on-board hydraulic system.

- ✔ Full functionality with a lower oil requirement
- ✔ Without a complex on-board hydraulic system



Hybrid drive with combined oil supply

- Oil requirement with steering axle max. 85 l/min
- Oil requirement without steering axle max. 60 l/min

- ❗ "The consistently stable speed of the discs and also, above all, the possibility of different disc speeds is a dream. You only come to know and appreciate the benefits offered by the hydraulic system when you have used it"

("profi" – Spreading units in practice "Hydraulic or mechanical" - 06/2017)

Soft Ballistic System pro

For an even gentler fertiliser handling



Decisive advantages with SBS pro

Mineral fertiliser needs to be gently handled to ensure a precise distribution and an exact placement to the plant over the entire working width. Fertiliser, which has been damaged whilst going through the spreader, will not be precisely distributed.

The Soft Ballistic System pro 'safety pack' is integrated as standard. The agitator, metering components and spreading discs are optimally tailored to each other. This protects the fertiliser and secures your yields.

1. Gentle guidance

The electrically-driven star agitators in the hopper bottoms ensure an even fertiliser flow onto the spreading discs. The slowly rotating, star shaped segments of the agitator evenly deliver the fertiliser to the relevant shutter opening. When the delivery system is adjusted, the agitator star rotates as well so that it is always perfectly positioned above the aperture. The agitator switches off automatically when the shutter slide is closed.

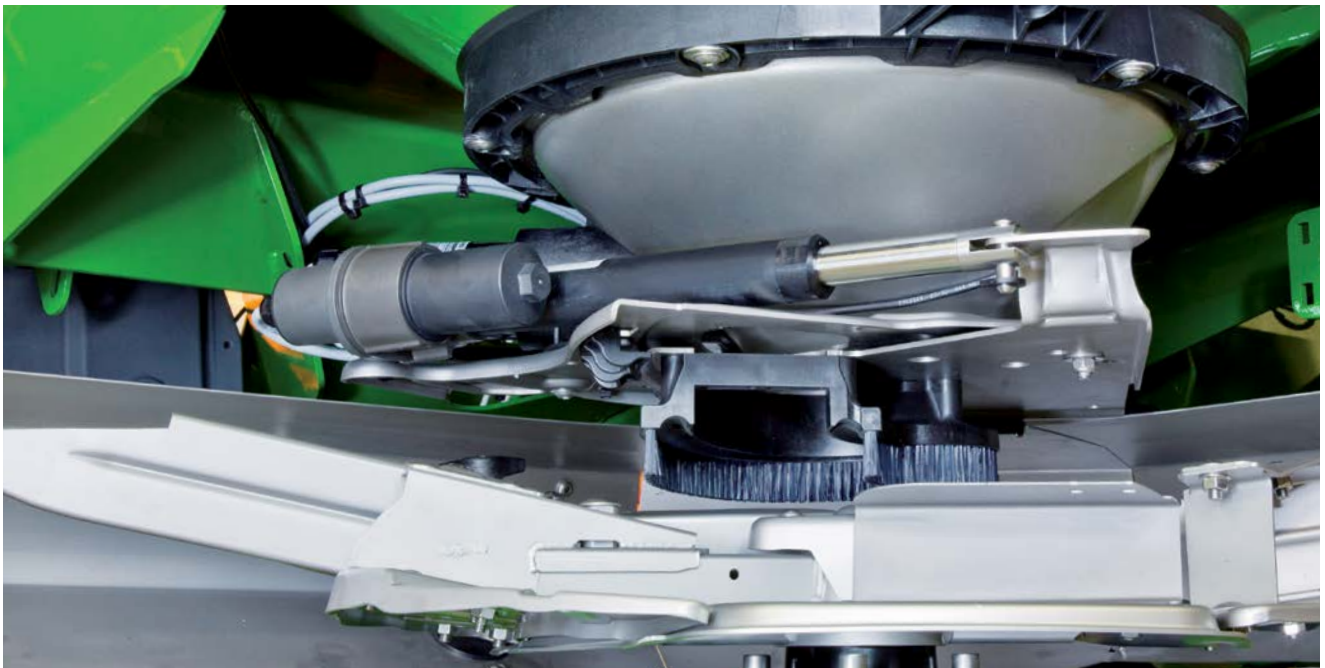

✔ Spreading system with delivery system, brush kit and spreading disc

2. Gentle delivery

Due to the delivery system, adjustment of the throwing width and throwing direction can be regulated. In addition, the working width can be adjusted each side individually by changing the disc speed. The fertiliser is fed on centrally at a low peripheral speed resulting in little fertiliser damage. The concentric delivery system adjustment results always in a gentle handling of the fertiliser.

3. Gentle acceleration

With a standard disc speed from 600 rpm to 900 rpm, the Soft Ballistic System pro gently accelerates the fertiliser.

Even fertiliser types with minimal breaking strength maintain their spreading properties and provide a clean, even spread pattern.

4. Gentle ejection

With the Soft Ballistic System pro, as little energy as possible is given to the fertiliser for an optimum trajectory and a precise spread pattern. So, the spreading vanes are optimally adjusted to a laid-back position.



TS spreading system

Perfection in every component, just like clockwork

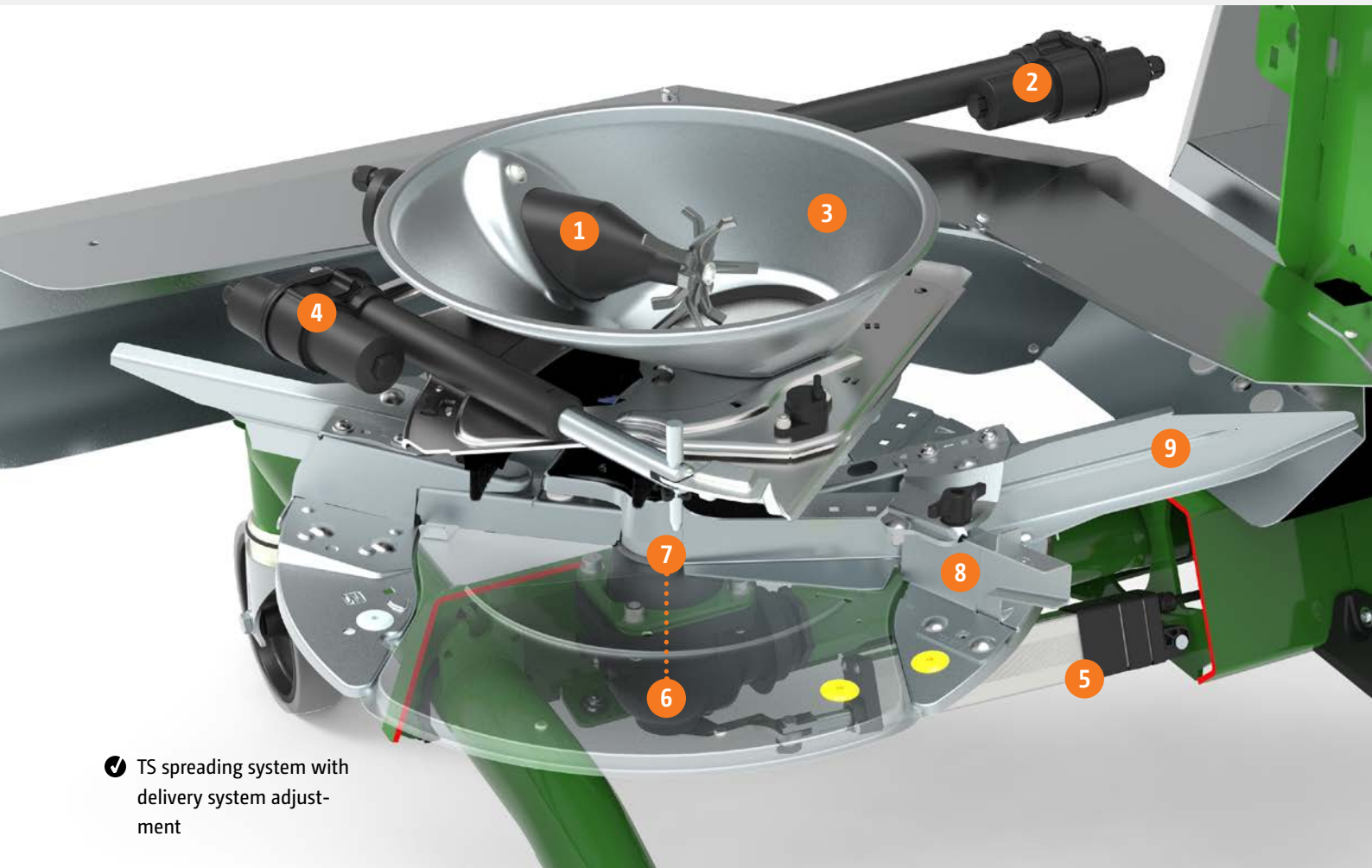

- ✓ TS spreading system with delivery system adjustment

Characteristics of the TS spreading system

Delivery system adjustment of the TS spreading system

- 1) Intelligent agitator for maximum fertiliser protection
- 2) Electric setting motor for rotating the delivery system
- 3) Delivery system for implementing the Section Control, HeadlandControl and WindControl functions ArgusTwin
- 4) Electric setting motor for a precise fertiliser metering with application rates from 3 kg/min to 650 kg/min

Bottom assembly of the TS spreading system

- 5) Electric setting motor for adjustment of the carrier vane
- 6) AutoTS gearbox, the heart of the integrated border spreading system
- 7) Comfortable changeover between border and normal spreading by moving the carrier vane
- 8) Short border spreading vane for sharp side, border and water course spreading
- 9) Long normal spreading vane for high throwing widths and double overlap, even at a working width of 36 m

- ❗ “A 12V motor drives the agitator which rotates at 60 rpm. It switches off when the shutter is closed and it reverses as soon as a foreign object blocks the agitator.”

(dlz agrar magazine – Long term test ZA-TS 3200 Profis Hydro · 02/2017)



The agitator – soft-handling and gentle

The basic function of the agitator is to convey the fertiliser actively towards the shutter aperture, so that a constant rate of fertiliser can be applied. Fertiliser lumps, which manage to pass the sieve, are, especially at low application rates, actively broken up via the star agitator which runs in the hopper bottom. If a foreign object reaches the hopper tip and the agitator is subject to an excessive load, the relevant electric motor automatically reverses in combination with the relevant shutter slide opening and remedies any blockage autonomously. The perfect interaction of agitator and shutter slide becomes obvious on headlands or when spreading in wedge-shaped fields. As soon as one metering aperture is completely closed, the agitator above stops

automatically. In this way the valuable fertiliser is protected from being ground up.

The benefits of electric agitation

- ✔ two slow-running, fertiliser-protecting agitators; turning at just 60 rpm
- ✔ that switch off automatically as soon as the shutter slide is closed, also just to the one side and independently of each other
- ✔ that reverse automatically when blocked by a foreign object
- ✔ active delivery of the fertiliser flow to the aperture



- ❗ “The electric agitators operate independently left or right and only when that shutter is opened”

(profi – Practice Test “Four fertiliser spreaders in comparison” · 01/2016)

The AMAZONE delivery system

for first-class spreading results

Concentric delivery system adjustment

The fertiliser is mainly deposited, via the delivery system, and thus in as gentle a manner as possible, at the centre-point of the spreading discs. The circumferential speeds are low at this point on the discs, and the fertiliser is handled very gently. For setting the spreading unit to different working widths and different types of fertiliser, the delivery system is swivelled (concentrically) around the centre of the discs. The distance between the feed-on point of the fertiliser and the centre of the disc always remains the same.

The swivelling of the delivery system offers a wide bandwidth of possible working widths. The range of 15 m to 54 m working width is covered by just three sets of spreading vanes.

All TS spreading systems with electric delivery system adjustment are suitable for the ArgusTwin spread pattern monitoring system.

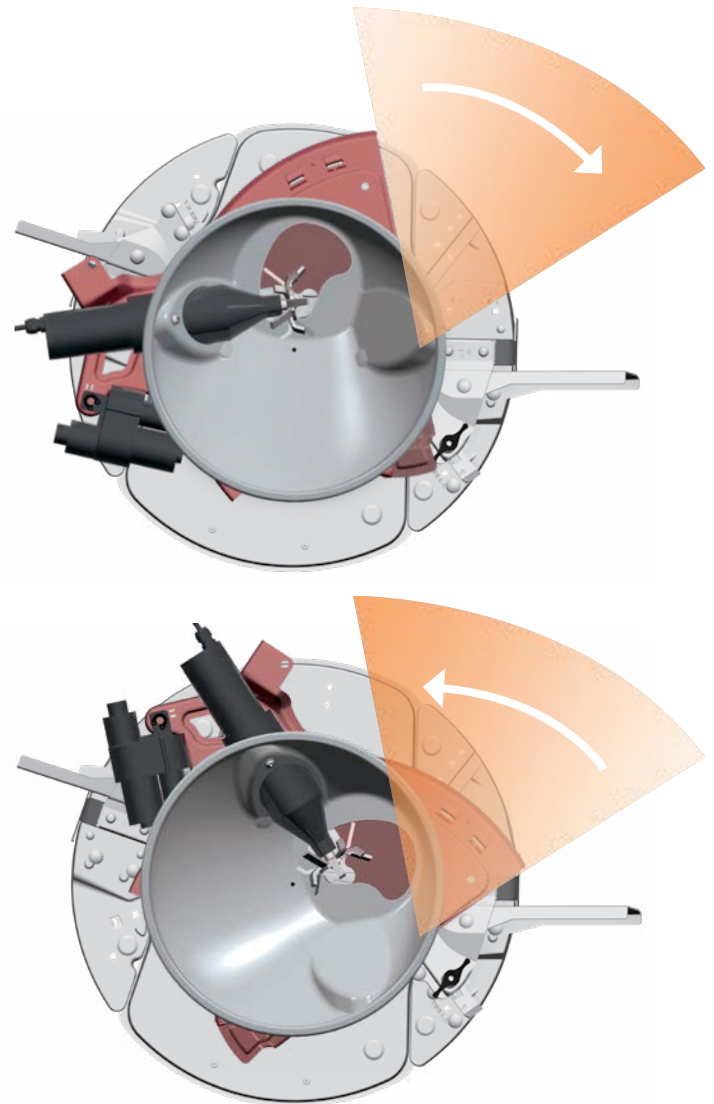

✔ The delivery system swivels around the centre of the disc

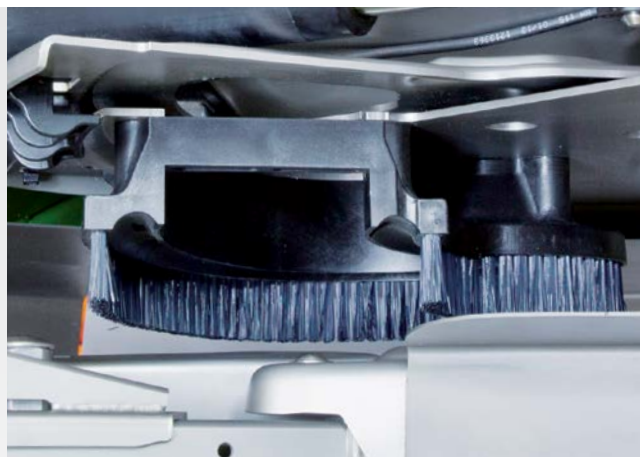

✔ Brush unit for a clean delivery onto the spreading discs

Ultra-quick and precise! Electric setting motors

A spreader which, due to the high application rates and operational speeds possible, explores new dimensions in terms of work rates and which, of course, needs to perform extremely precisely at the same time. This requires setting motors that function extremely quickly and exactly. Especially in applications, such as the automatic on/off switching at the headland or in wedge-shaped fields, spreading using application maps or with the continuous on-board monitoring (ArgusTwin and WindControl), the setting motors ensure the highest level demands are met.

Clean transfer – the brush unit

The bristles of the brushes which are fitted directly to the apertures reach to the upper edge of the spreading vanes so that the fertiliser is safely delivered onto the disc.

Quantity effect-free metering aperture

If it is intended to spread a constant application rate it is necessary to match the size of the aperture to the prevailing forward speed. Thanks to the shutter slide, this task is fulfilled very quickly and sensitively. Due to the

kidney-shaped design of the metering aperture, the spread pattern remains unchanged and precise, even at varying forward speeds so that the position of the delivery system does not require any adjustment.



Stage 1: hopper aperture slightly open



Stage 2: hopper aperture half open



Stage 3: hopper aperture wide open

TS spreading discs

For the utmost precision at all spreading widths up to 54 m

Spreading system made from stainless steel – for a long service life

On the TS spreaders, the entire spreading system is made from stainless steel ensuring a long service life.

The different spreading vane sets can be quickly and easily exchanged using an interchangeable system. The ideal solution, for example, for agricultural contractors.

Between normal spreading and border spreading, different spreading vanes are activated via the so-called AutoTS system without the necessity to change spreading disc settings.

Hard-metal-coated spreading vanes

The spreading vanes are coated with a special long-lasting anti-wear protection. Consequently, the result is a three-fold increase in lifespan.

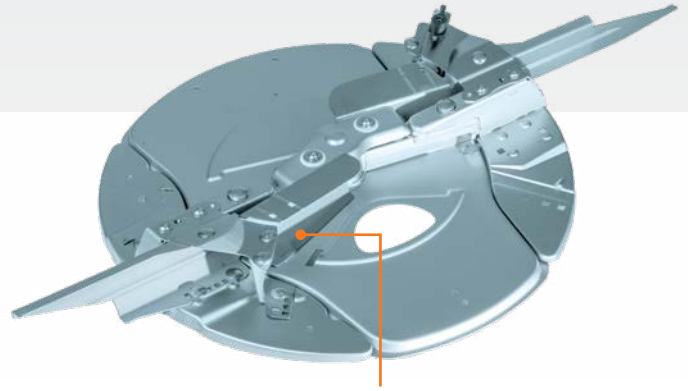

The integrated AutoTS border spreading system is activated electrically.

- 🔧 "For different working widths it is then just a case of interchanging the spreading vane set – a very comfortable solution." (profi – Driving impression ZA-TS 4200 Profis Hydro fertiliser spreader– 06/2013)

Optimum working width ranges of the spreading vane sets, depending on the fertiliser being spread:

- 🔧 TS 10 = 15 m – max. 27 m
- 🔧 TS 20 = 21 m – max. 33 m
- 🔧 TS 30 = 24 m – max. 54 m

Range of working widths for spreading vane sets

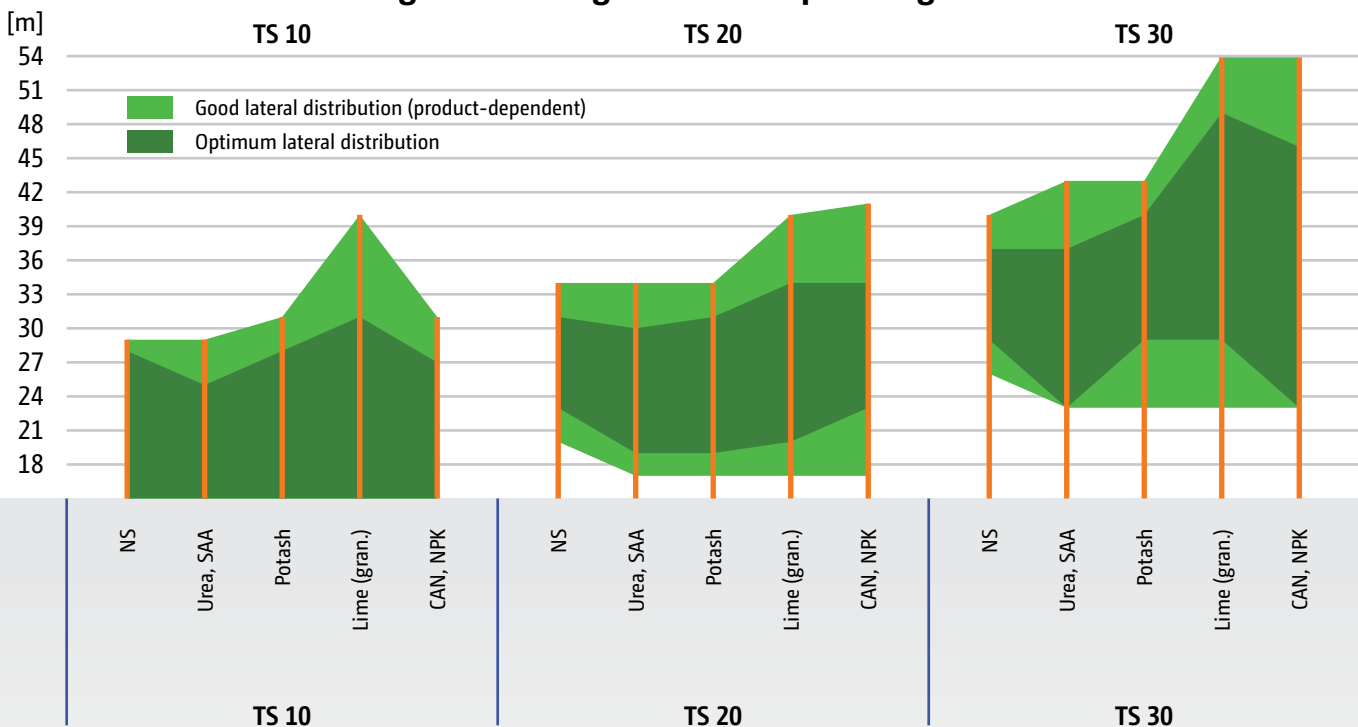

Optimised spread pattern



Normal spreading

Via the adjustment of the delivery system, the feed-on point of the spreading material on to the spreading disc is changed and thus the spreading width and the lateral distribution are controlled. In addition, the working width can be set even more individually by changing the disc speed.

Non-sensitive spread pattern via the multi-sectional spread fan

The specific profile and angle of the spreading vanes result in a multi-spread fan from the TS spreading unit. This means that the pattern of the fertiliser from the long and short spreading vanes do not influence each other and so an optimum trajectory is maintained.

Three-dimensional spread pattern

The spreading unit has been developed using three-dimensional spread patterns so that a perfect lateral distribution of up to 54 m working widths is achieved. The large overlap zones ensure a perfect spread pattern and are significantly more consistent with regard to any external influences such as side winds, a change in topography, humidity or changing fertiliser quality.

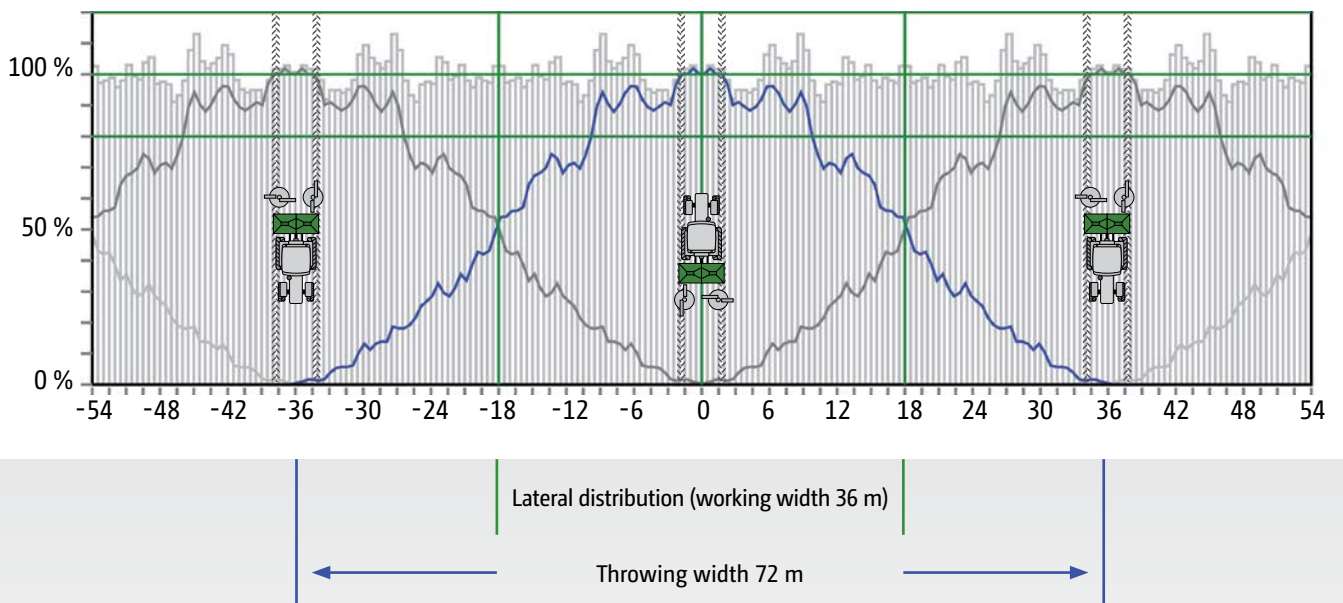
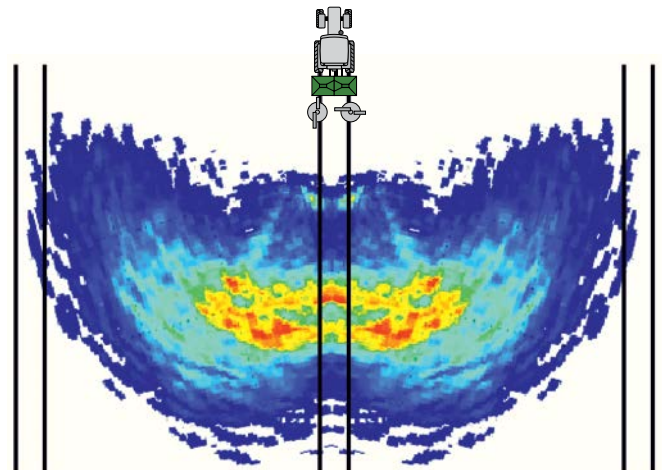

Border spreading systems from AMAZONE

Complete control. At all times!



- ❗ Boundary spreading systems make particular sense when application rates are high. In these cases the more expensive systems will also pay off.
(top agrar - "Precision goes boundary spreading" - 07/2022)

- ✔ AMAZONE offers setting recommendations for all border spreading techniques

Effective and precise – spread only where the fertiliser will benefit plant development

Side spreading (yield-oriented adjustment)

The neighbouring field is an area that is used agriculturally. In this case it is tolerable for a small quantity of fertiliser to be thrown over the field border. The full target rate is applied right up to the field boundary.

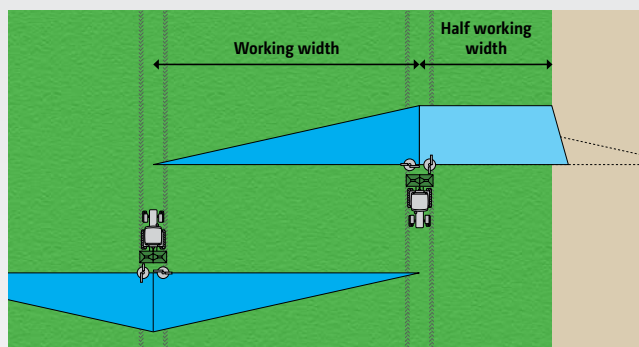

Border spreading (environmentally-oriented adjustment)

If the field is adjacent to a road or cycle path, no fertiliser may be thrown beyond the field border. In this case, the throwing distance is adjusted in combination with the shutter slide.

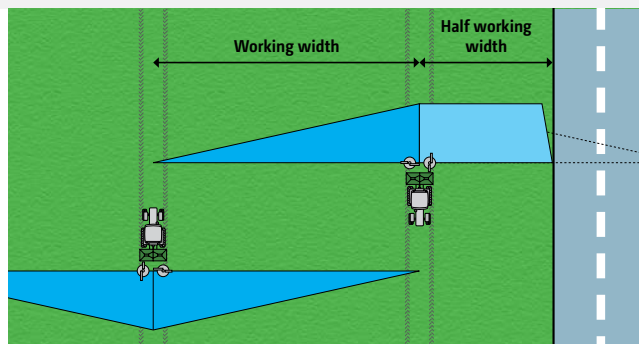

Water-course spreading (environmentally oriented adjustment)

If there is a body of water directly at the edge of the field, a defined distance away from the water must be maintained when fertilising according to the fertiliser regulations. For this purpose, the throwing distance is further reduced in combination with the shutter slide.

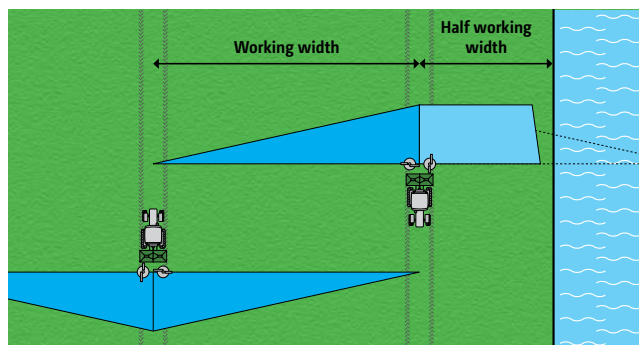

BorderTS in combination with AutoTS

Using the BorderTS deflector means that the full amount of fertiliser is applied right up to the field boundary, without spreading beyond it. In combination with AutoTS, the area between the first tramline and the field boundary is fertilised with the desired application rate. A sharp-edged cut-off right up to the field boundary is achieved.

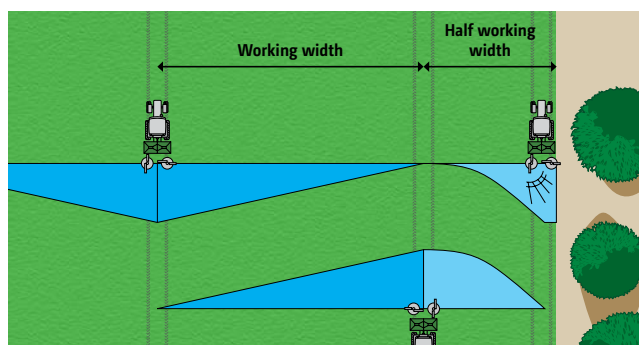

Bed spreading with bed spreading deflector for both sides

For spreading specialist crops in beds to either side of the tractor, AMAZONE offers the bed spreading deflector. It keeps the track virtually free of fertiliser. Actuation of the bed spreading deflector is carried out hydraulically from the tractor seat.

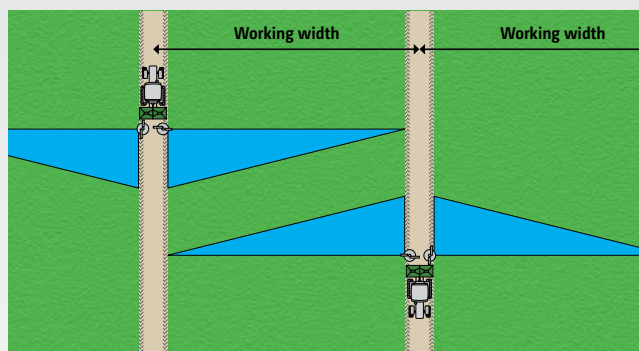

AutoTS

The disc-integrated border spreading system

AutoTS – Comfortable adjustment and precise lateral distribution right up to the field border

The disc-integrated AutoTS border spreading system, enables the activation of the different border spreading techniques – side, border or watercourse spreading – comfortably via the terminal in the tractor cab and irrespective of which side.

AutoTS – the ingenious principle

A setting motor twists the carrier vane forwards by approximately 10 ° so that, when border or watercourse spreading, the fertiliser is delivered via the shorter border spreading vanes. Due to the combination of disc speed and a shorter vane, the fertiliser is thrown over a significant shorter distance without affecting it mechanically.

AutoTS – setting for normal spreading



Border Spreading Calculator – calculate those additional profits

With AutoTS, an average increase in yield of about 17% can be achieved around the field boundary compared with other well-known systems. Calculate it for yourself now!

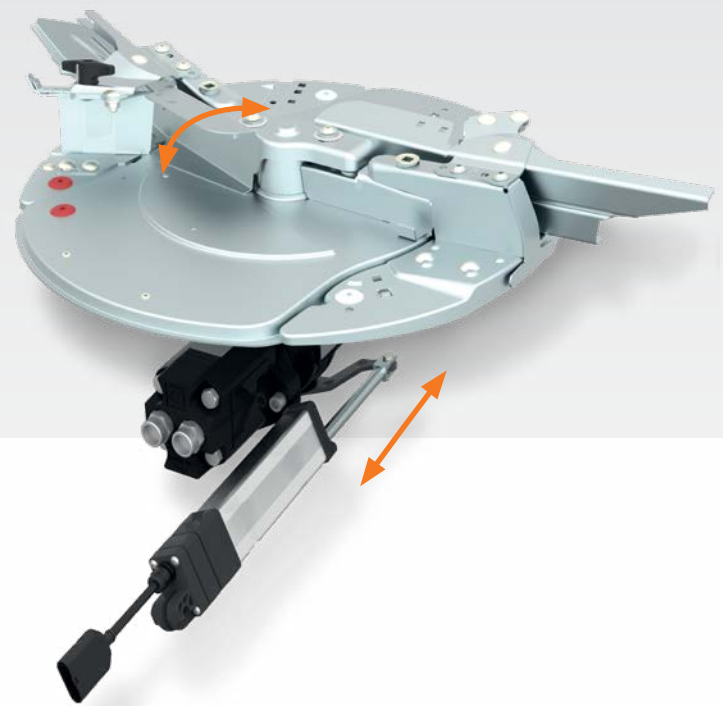

AutoTS – adjustment of the carrier vane for border spreading

- ① “The design specification for the development of the Amazone ZA-TS was clear: no longer should there be any compromise between normal spreading and side, border and watercourse spreading around the field boundaries.”

(profi – Spreading systems in practice “hydraulic or mechanical” · 06/2017)

AutoTS – setting of carrier vane for border spreading



Increased yield on the border thanks to AutoTS

Exclusive!

The AutoTS border spreading system makes it possible for the operator to reliably generate a very steep cut-off to the border spread pattern and thus create the perfect growing conditions right up against the field edge. Compared to other border spreading systems, a significant increase in yield is possible.

Automatic rate reduction when border spreading is possible with the AutoTS spreading unit. Rate changes are possible in freely-selectable percentage steps. As the two spreading discs can be operated independently from one another, the change can be applied to just one, or both sides.

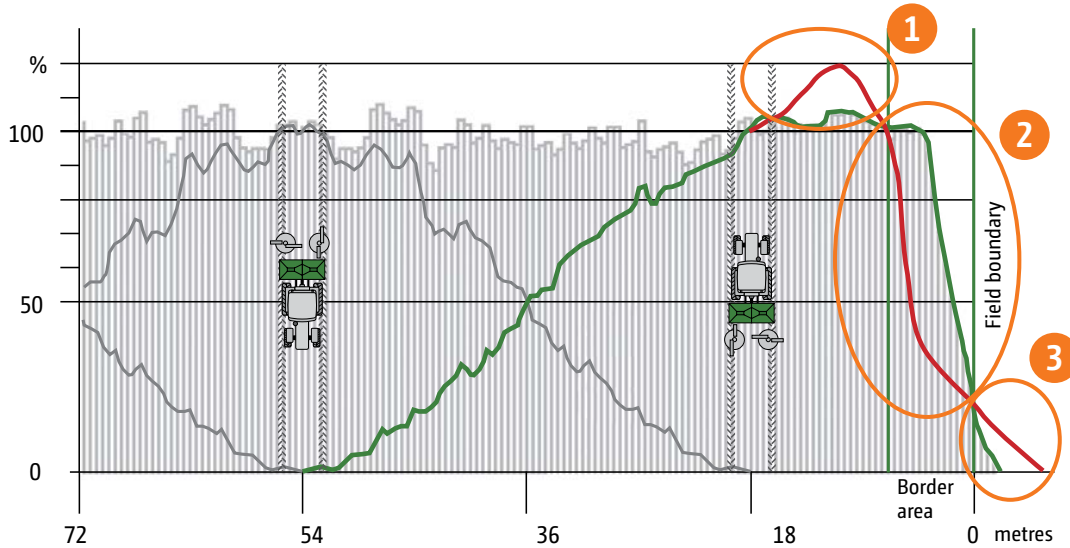

	AutoTS border spreading system	Conventional border spreading systems
1	A shorter spreading vane restricts the throwing distance of the fertiliser.	Mechanically diverting the fertiliser causes potential fertiliser damage, where the broken granules land next to the tramline.
2	The fertiliser is handled more gently and is optimally distributed right up to the boundary.	The broken granules are not spread out to the border area, resulting in under-fertilisation.
3	Due to the reduced throwing speed of the fertiliser, only a few granules land beyond the field edge.	Not all fertiliser granules are mechanically deflected, meaning that the fertiliser is spread well beyond the field boundary.

Exclusive!

BorderTS border spreading system

Spread only where the crop will benefit from the fertiliser applied



Maximum amount of fertiliser right up to the field boundary

AMAZONE has developed the BorderTS deflector for even more precise fertilisation up to the field boundary when spreading at those larger working widths. In contrast with conventional border spreading deflectors, the BorderTS deflector operates in collaboration with the AutoTS border spreading system integrated in the spreading discs. The spread patterns of both the BorderTS and the AutoTS are matched to each other.

All values can be stored in the spreader settings beforehand, so that the appropriate setting parameters are set automatically depending on the application situation.

- ❗ “With the BorderTS, Amazone offers an extended version of AutoTS, which delivers the full rate right up to the boundary.”
- ❗ “... BorderTS can be used for base fertiliser applications, on grass land and in row crops. In addition, a pass is also possible for that initial application in cereal crops with tramlines, as in our case. The wheel tracks at the field edge disappear in time. The plants get the full fertiliser rate and start the new season in good shape.”

(profi - “Border work” - 04/2022)

- ✔ Using the BorderTS border spreading system enables increased yields of up to 27% on the outer five metres of the field boundary area when compared with conventional border spreading systems.

Animation of the BorderTS border spreading system:
www.amazone.net/yt-border-ts





The BorderTS deflector is mounted centrally behind the spreader and is activated hydraulically.



When activated, the BorderTS deflector on the ZA-TS is swivelled into the spread fan from above. The special baffle plate construction and infinitely adjustable guide plate gently guide the granules to the ground.

Baffle plate construction with integrated software

At larger working widths, the fertiliser must be accelerated considerably more in order to achieve a good area of overlap with the spread fan from the first tramline. Due to the high energy of the granules, the evenness of distribution behind the tractor provided by conventional systems is often unsatisfactory. The BorderTS deflector features a special baffle plate construction which includes a guide plate, the angle of which can be adjusted. The baffles first remove the energy from the granules, which are then gently guided to the ground by the guide plate. The guide plate is infinitely adjustable for optimal application up to the field boundary. In addition, a sensor detects the working position. When the deflector is in use, the spread rate and the delivery point of the fertiliser onto the spreading disc are automatically adjusted to ensure the best possible lateral distribution in combination with the disc-integrated AutoTS border spreading system.

It goes without saying that the application rate can be manually overridden at any time in response to special situations.

- ❗ “Checking with the mats at the field boundary showed the effectiveness of the deflector in our application. At the same time, the fertiliser rate for the field was applied right up to the boundary after driving in the tramline and round the outside – excellent.”

(profi - “Border work” - 04/2022)

Illustration of the combined use of BorderTS and AutoTS

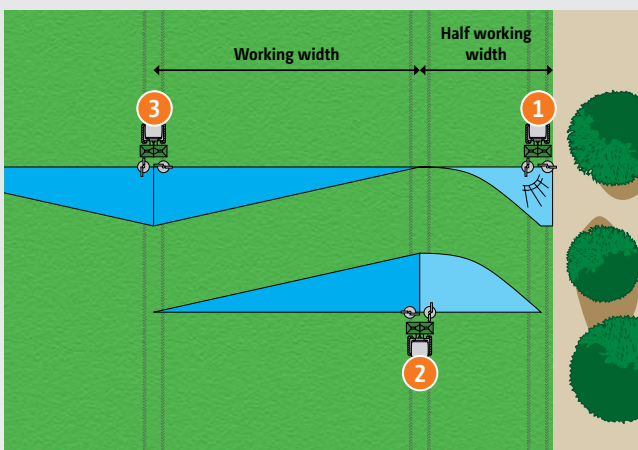

1. Fertiliser is spread from the edge of the field into the crop by the BorderTS deflector, with automatic reduction of the target rate to 50%. The shutter nearest the field boundary is left closed.
2. AutoTS spreads at 50% from the first tramline to the boundary side in order to achieve the target rate across the total field boundary area. Normal spreading to the field side with 100% of the target rate.
3. In the subsequent tramlines, normal spreading is resumed with 100% of the target rate to both sides.

Proven precision!

Innovation Farm field trial

INNO
VATION
FARM 

FARMING FOR FUTURE



✔ Large-scale field trials by Innovation Farm in Austria compared four border spreading systems under practical conditions.

Additional revenue per hectare of cropped area and per year with the use of the different border spreading systems at a width of 36 m (top agrar 07/2022, Source: Innovation Farm)

average field size	2 ha	4 ha	12 ha
Limiter	€ 52.28	€ 36.96	€ 21.35
Hydro	€ 56.04	€ 39.61	€ 22.89
AutoTS	€ 117.02	€ 82.71	€ 47.79
BorderTS	€ 121.22	€ 85.68	€ 49.50

Field trials prove the best border spreading results

The aim of the field trial was to demonstrate the fact that border spreading systems provide not only ecological benefits, but also that they have a great influence on the potential yield in the field boundary area.

Precise technology is required to spread the full rate of fertiliser right up to the field boundary, even at the larger working widths, as well as avoiding any fertiliser losses outside the field boundary.

AutoTS and BorderTS fulfil these requirements. This means that higher yields can be achieved, even at the field boundary.

Core messages of the trial

- ❗ “A wider working width or smaller field sizes increases the level of return on a boundary spreading system.”
- ❗ “The AutoTS and BorderTS spread patterns show a relatively even spread rate all the way up to the boundary where the rate then drops steeply.”
- ❗ “Any underdosage was clearly reduced by using AutoTS and BorderTS, which translates into higher yields.”
- ❗ “This means that using both AutoTS and BorderTS is beneficial at the larger working widths.”

(top agrar - “Precision goes boundary spreading” - 07/2022)

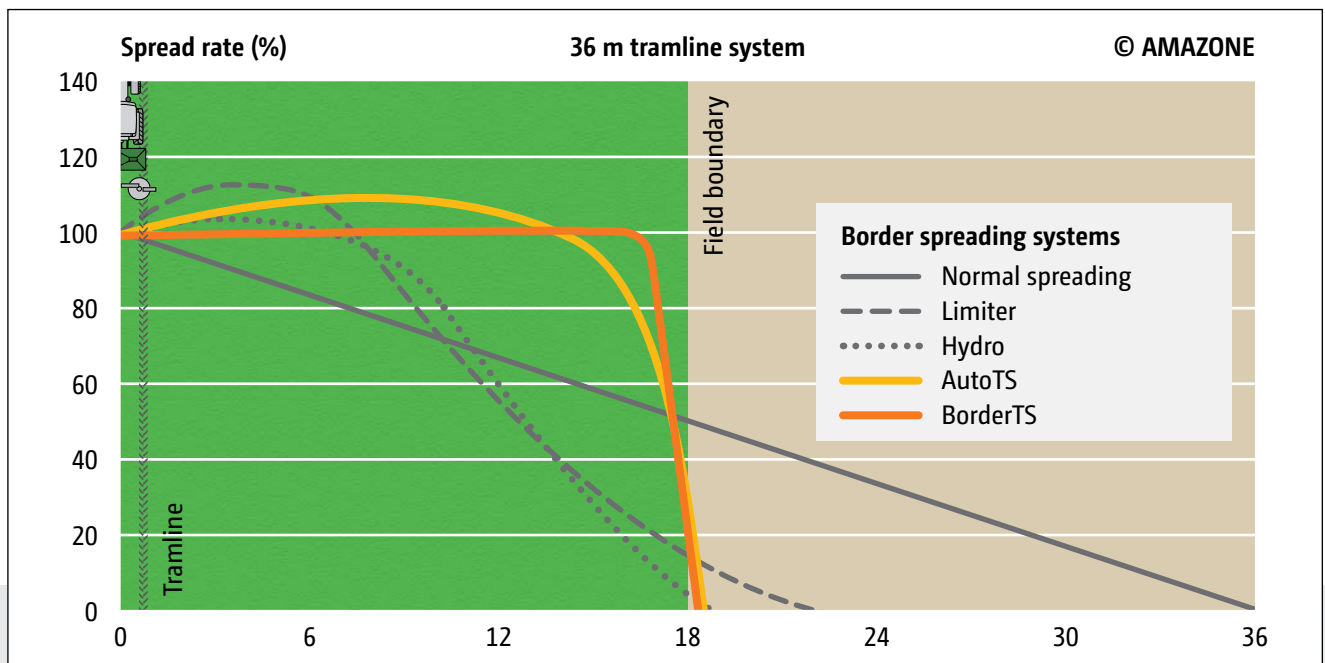

The illustration shows the border spreading procedure, whereby ideally no fertiliser should be spread beyond the field boundary.

- ❗ “... This was different on AutoTS and BorderTS which continued to apply a very even spread.”

(top agrar - “Precision goes boundary spreading” - 07/2022)

Exclusive!

HeadlandControl

Optimum lateral distribution on the headland

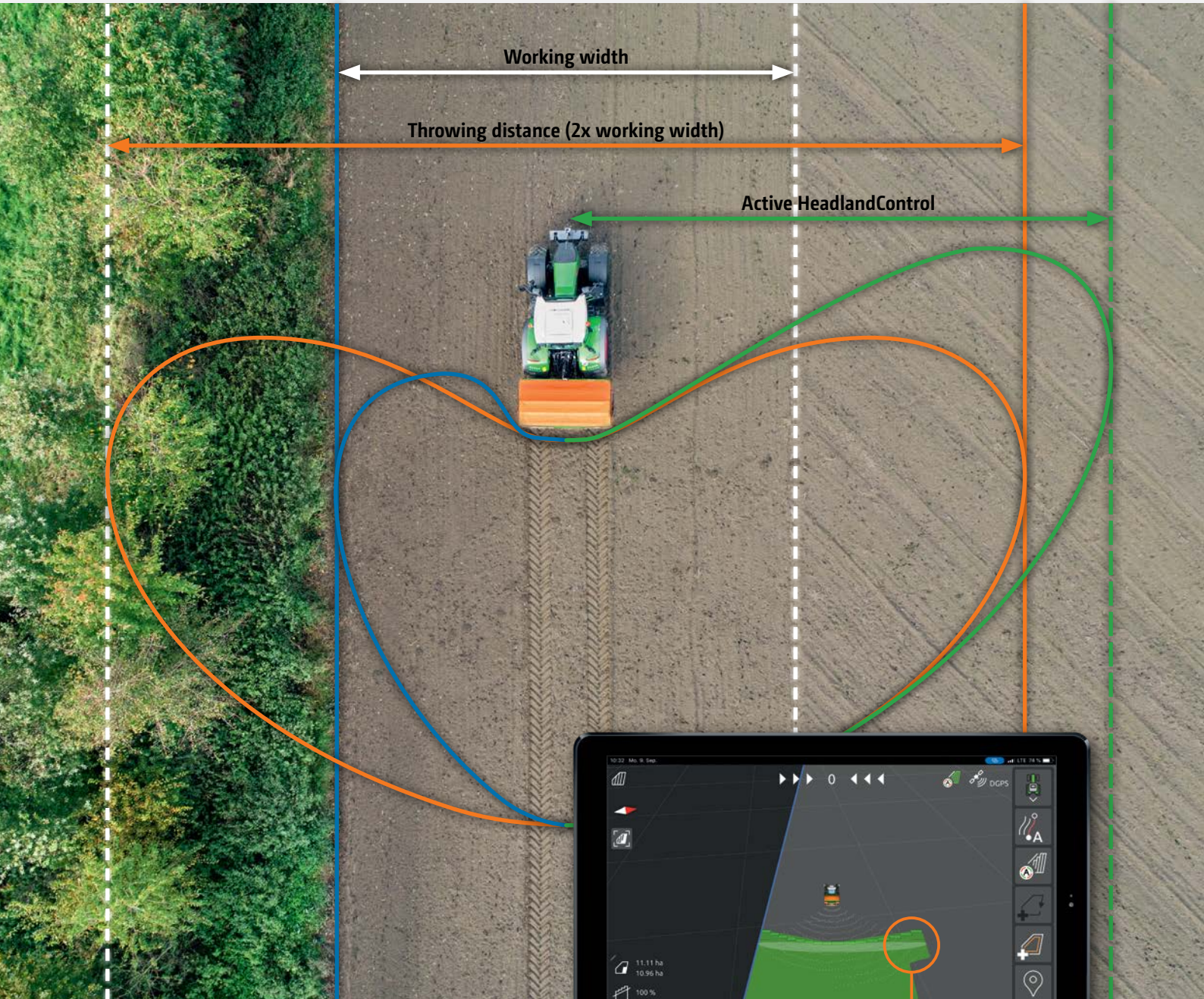

- HeadlandControl
- Normal spreading
- Border spreading

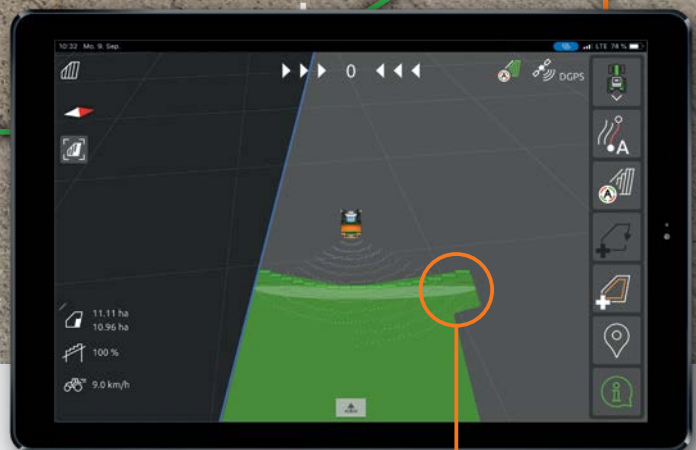

HeadlandControl provides an increase in the working width towards the inside of the field on the headland.

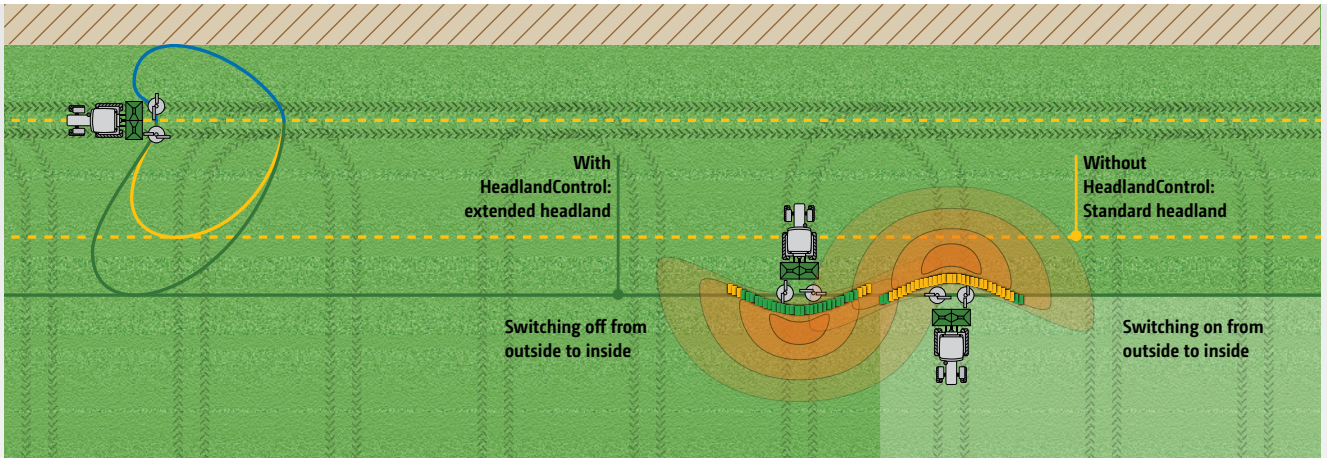

Perfected headland coverage thanks to HeadlandControl and the new part-width section control

The problem: over- and under-fertilisation on the headland

Fertiliser spreaders have a high throwing distance behind the machine. In practice, the switch-off points are usually only achieved when the tractor is turning on the headland. The arc of spread behind the tractor and round to the side creates areas that are either over- or under-fertilised.

The solution: HeadlandControl

When HeadlandControl is activated, the throwing width and spread rate are increased on the field side, so that the switch-off point is moved towards the inside of the field. Furthermore, the new part-width section control, which is now adapted to the shape of the spread fan, causes the part-width sections to be switched off from the outside to the inside when entering the headland. Over- and under-fertilised zones on the headland are subsequently avoided.

Switch-off time on the headland: Without HeadlandControl

1. Spreader switches off too late and is already turning
2. Tractor would have to drive beyond the headland tramline

Result: over- and under-fertilised zones are created

With HeadlandControl

1. HeadlandControl means that the spreader continues to apply fertiliser to the crop when it is on the headland
2. The tractor can follow the wheel tracks of the crop protection sprayer

Result: uniform crops across the full headland

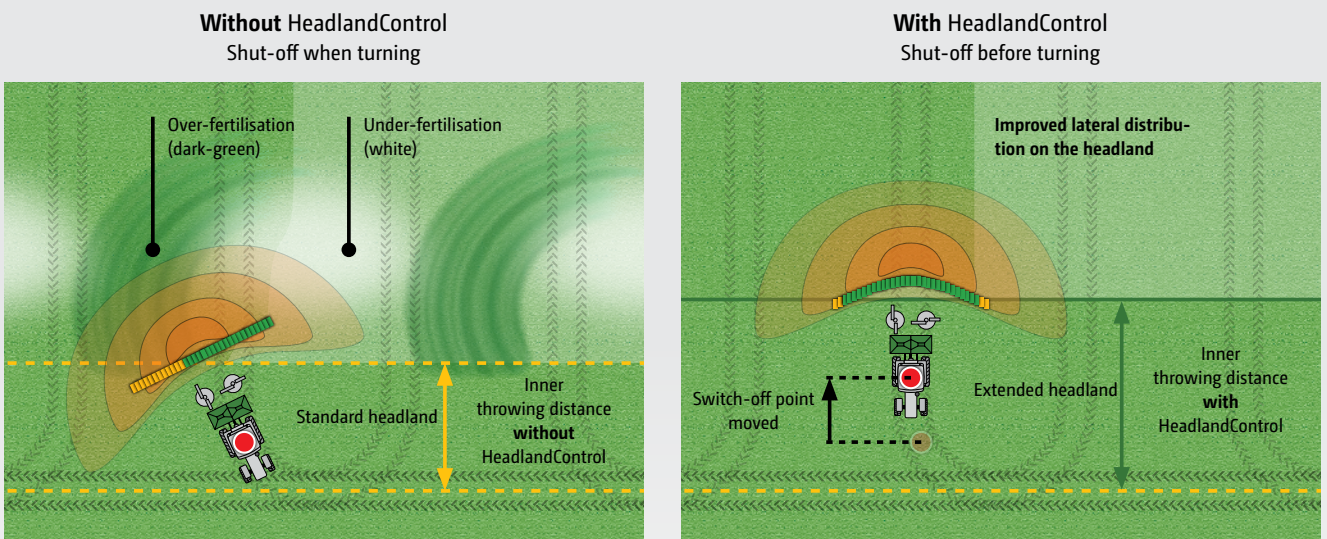

"More than ISOBUS" functions from AMAZONE extend beyond the ISOBUS standards. Because of this, HeadlandControl, amongst other things, does not function on all ISOBUS terminals.

Exclusive!

WindControl

Don't give wind a chance!

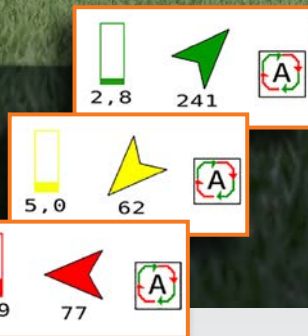

AMAZONE WindControl ensures an optimum lateral distribution even in crosswinds

- ✔ WindControl traffic light system
 - Green: Unlimited spreading
 - Yellow: Increased control in border areas
 - Red: Stop spreading!

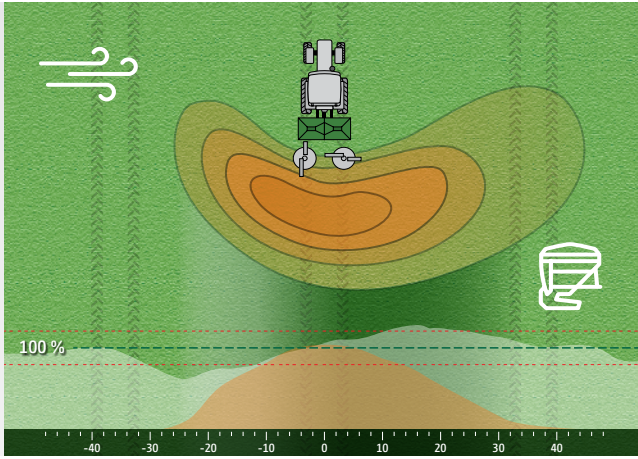

Without WindControl: Crosswinds affect the spread pattern and change the lateral distribution

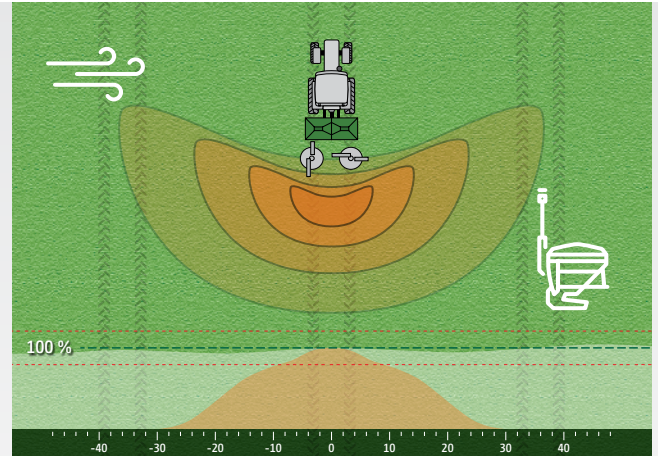

With WindControl: WindControl counteracts the effect of a crosswind ensuring an optimum spread pattern at all times

Optimum lateral distribution

The wind is always blowing somewhere in the world and this represents a major challenge in maintaining an even fertiliser spread pattern. The influence of wind on the spread pattern can be constantly monitored and automatically compensated for with the AMAZONE WindControl system (according to Prof. Dr. Karl Wild of the University of Applied Sciences, Dresden).

Mounted on the machine, a high frequency measuring wind sensor, registers both the wind speed and also the wind direction. According to this data, the job computer then calculates new settings for the delivery system and the spreading disc speed. In a cross wind, the disc speed is increased on the side into the wind and the delivery system is rotated outwards. At the same time, the speed of the downwind side is reduced and the delivery system rotated inwards.

With the aid of WindControl, larger time windows are created for spreading even where there is an influence of wind. Apart from all the important fertiliser spreader parameters, the user additionally always has, in view, the real-time direction of the wind, the force of wind and if the wind is gusting. In addition, WindControl issues an automatic warning to the driver in the event of strong winds, when the system is no longer able to compensate for the effects of the wind or when gusts of wind change too frequently.

The benefits

- ✔ Higher output through longer windows of use
- ✔ Increased yield through optimised lateral distribution
- ✔ Operational safety via the automatic warning system

WindControl in practice

Key data and information

- Field size 70 ha
- Wind speeds of up to 27 km/h
- WindControl improves the lateral distribution across 70 % of the area*

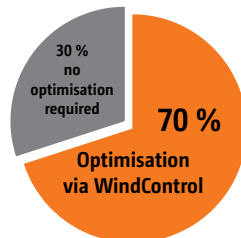

INFORMATION ON THE FIELD TRIAL
www.amazone.net/windcontrol

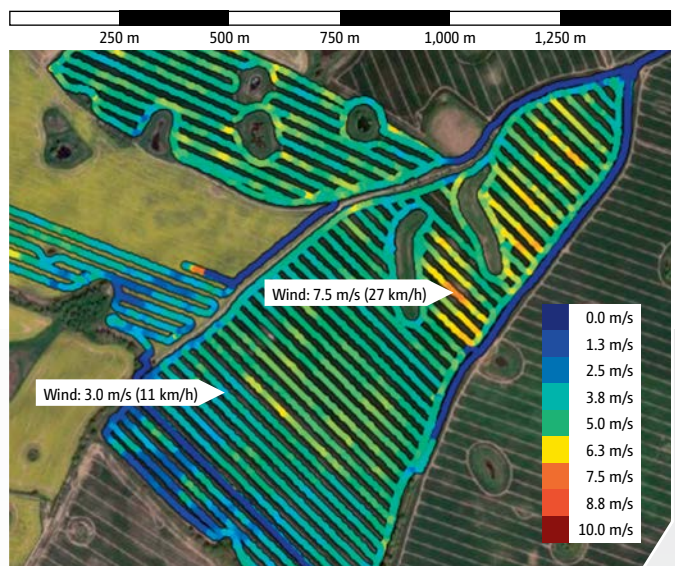

ArgusTwin

The spreader's eyes – they see what you don't see!



Argus

! "ArgusTwin optimised the lateral distribution within seconds."
("profi" – Test report Amazone ArgusTwin · 01/2016)

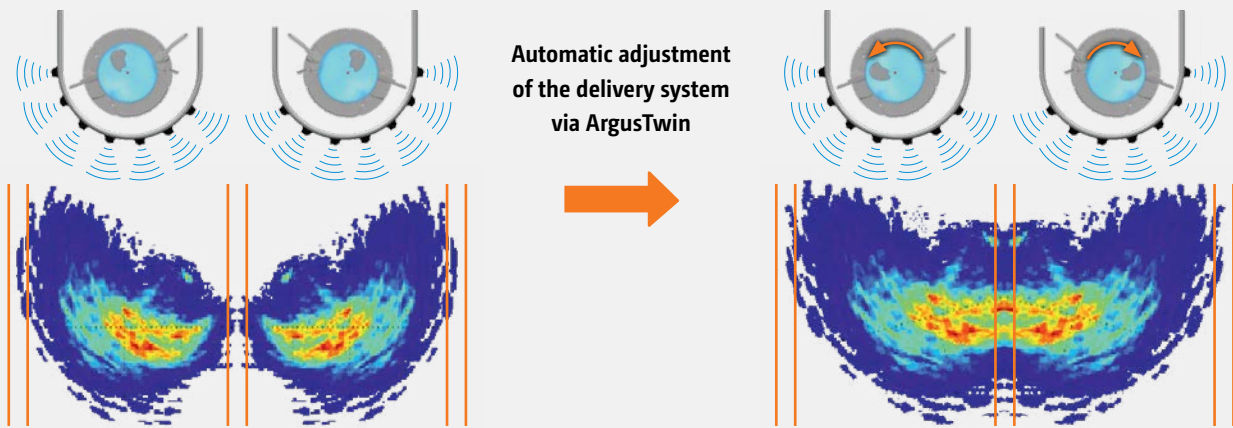

The problems in practice – poor lateral distribution, for instance, due to a change in fertiliser properties

Perfect lateral distribution enables uniform crops, even with varying fertiliser quality and properties

Automatic adjustment to the optimum lateral distribution

Via the constantly working on-line monitoring and readjustment of the delivery system, the ArgusTwin system ensures an optimum lateral distribution of the fertiliser. This leads to a more effective fertiliser use and forms the basis for optimum crop management.

The Argus system, which checks the spread fan and automatically regulates the lateral distribution, is based on radar technology that is independent of dust and pollution and thus provides reliable results in practice. ArgusTwin constantly monitors, via radar sensors mounted on both the sides of the spreader, the left and right hand spread fans simultaneously and readjusts the electric delivery system independently of each other if necessary.

Automatic delivery system adjustment

Via the ISOBUS terminal, the application rate, and any further relevant data relating to the fertiliser to be spread, are entered from the setting chart. For the Argus system, the spreading chart has been updated to include the throwing angle that gives the optimum lateral distribution. Utilising this value, ArgusTwin constantly checks whether the predetermined direction of throw for that fertiliser is in fact being maintained by the spreading discs. When the actual throwing width deviates from the “desired” throwing width

due to inconsistencies within the fertiliser, worn spreading vanes, working across slopes or during starting and stopping procedures, the spreader readjusts, on its own, the setting for the delivery system – and that of each side individually. The only pre-condition for its use is the electric delivery system adjustment.

The benefits

- ✔ Constant on-line monitoring of both spread fans
- ✔ Maintains an optimum lateral distribution of the fertiliser even with:
 - variable fertiliser quality
 - environmental influences, such as moisture and dew
 - Fertiliser coating on the spreading discs
- ✔ Automatic slope compensation of the spread pattern
- ✔ Positioned protected directly above the spreading discs



REACTION FROM THE END USERS!
Find out more

Optional equipment

Perfect down to the last detail



✔ Hydraulic parking jack

SafetySet – integrated as standard More safety for both people and machine

As with all equipment from AMAZONE, the ZG-TS has a very high level of base equipment to ensure the safety requirements are fulfilled correctly. The lighting system with its state of the art technology (LED lights) ensures safe road transport and is, in addition, long-lasting and robust.

Hydraulic parking jack – quick coupling and uncoupling

To enable the coupling and uncoupling of the ZG-TS with as much ease and speed as possible, the ZG-TS trailed spreaders feature, as standard, a hydraulic parking jack. To maintain the high ground clearance, the stand, when folded away practically disappears entirely into the frame.

Work lighting kit – as bright as day at any time

With the optional work lights, all the main areas of the spreader can be sufficiently illuminated when operating at night. For monitoring the fill level and for when loading, high-capacity LED spot lights illuminate the inside of the hopper.

For checking the agitators and for changes in the spread pattern, additional work lights are installed. In addition, work lights are attached to the sides which illuminate the spread pattern at nighttime and at the same time can be utilised as a filling aid.



Work lights inside the hopper

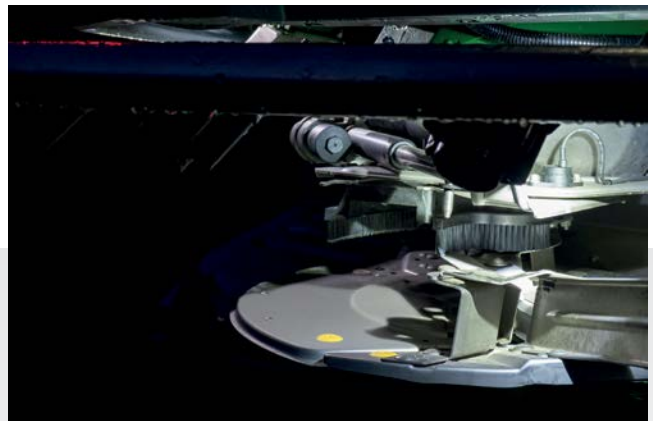

Illuminated spreading disc at night

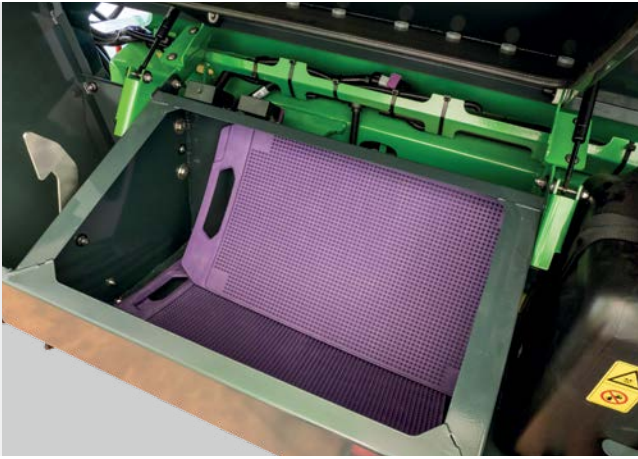

❗ “Two transport boxes offer sufficient storage space“
 (“profi“- Test report ZG-TS 01 ProfisPro · 06/2018)



✔ Hand wash tank – for better cleanliness in the tractor cab

The transport boxes – practical and spacious

Perfectly integrated and well within reach, for example, the EasyCheck mobile test kit can be stored on-board. The very large storage compartments provide the possibility to transport additional spreading vane sets and other tools.

The roll-over hopper cover – Comfortable and reliable

Also the hydraulically-controlled, roll-over hopper cover is especially comfortable. It can be unrolled and retracted comfortably and safely from the tractor cab. Thanks to the clever tensioning mechanism, the cover rolls up firmly and tight to the hopper so that no water, dirt or fertiliser can collect there. The cover, when firmly rolled away, also ensures that almost the entire hopper opening can be used without a troublesome rod or a loosely hanging cover getting in the way.



✔ Hydraulically actuated roll-over hopper cover

Hand wash tank

As standard, on the left hand side of the machine, a hand wash tank is integrated in the machine so that, even after a stoppage, you can wash your hands before continuing to work.

Camera system for the ZG-TS – Safety first!

The optionally available camera system mainly serves for safety when manoeuvring. The high resolution, antiglare monitor is backlit and can also display two cameras at once. The coupling to an ISOBUS terminal with an analogue video input is also possible.



✔ With the analogue video input on AmaTron 4, the picture from the camera can also be displayed alternatively.

ZG-TS Truck

Precision combined with the advantages of the carrier vehicle



15 m – 54 m



7,500 l and 10,000 l



128 part-width sections



Fertiliser, pelleted materials,
seeds, slug pellets



✔ ZG-TS Truck in work



✔ ZG-TS Truck in work

More efficiency and flexibility

The ZG-TS Truck demount spreader is the ideal solution for contractors and farms that need to quickly travel large distances between the field and yard. In addition, the spreaders can be used on a carrier vehicles with larger ground clearances and track widths, so that the range of application is increased. The work rates can also be considerably increased with a self-propelled machine. Since the ZG-TS Truck is also supplied as a mounted spreader with the intelligent ProfisPro, WindControl and ArgusTwin systems, it also sets new standards in the self-propelled machine segment as far as precision is concerned.

Advantages of the ZG-TS Truck

- ✔ Better manoeuvrability in the yard and in the field
- ✔ More efficiency on the road thanks to higher transport speeds
- ✔ Benefits of the carrying vehicle, such as, larger ground clearance and track widths
- ✔ Optimum centre of gravity by emptying from back to front



PRODUCT FILM
Find out more

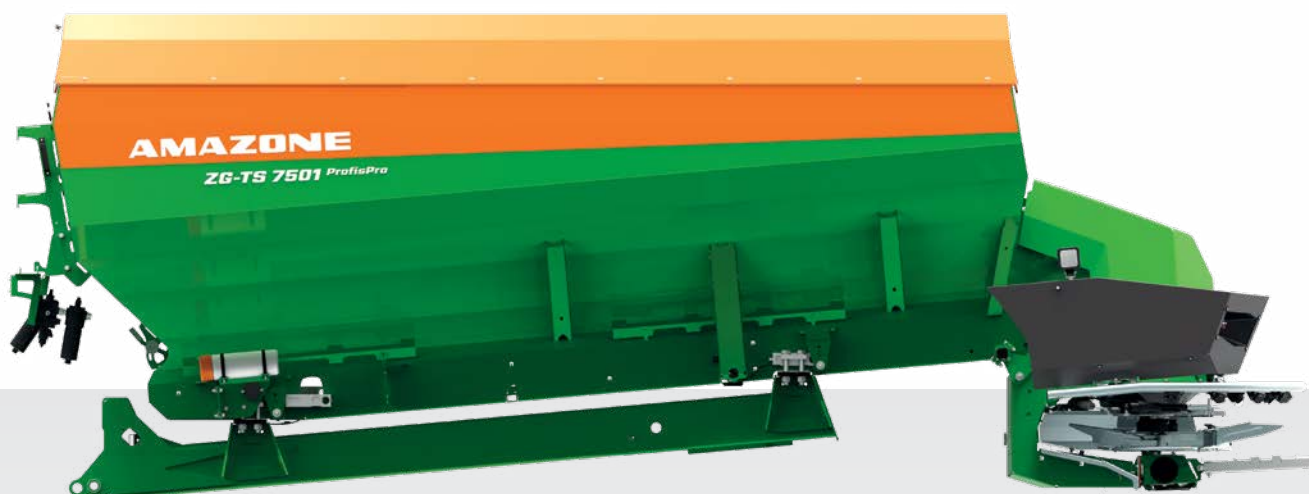

✔ Optimum weight distribution due to the hopper being inclined forwards

MEMBER OF



ISOBUS as the basis for intelligent communication

One language, many benefits!

Each ISOBUS-enabled machine from AMAZONE comes with the latest technology and almost unlimited possibilities. It makes no difference whether you use an operator terminal from AMAZONE or an ISOBUS terminal fitted directly in the tractor. ISOBUS is an internationally recognised standard for communication between the operator terminal, tractors and connected implements on the one hand and Farm Management Information Systems on the other.

Operation via a wide-range of ISOBUS terminals

Which means that ISOBUS enables you to take control of all your ISOBUS compatible equipment. You only have to connect the machine to the respective ISOBUS terminal and the usual operator interface appears on the monitor in your tractor cab.

Benefits of ISOBUS at a glance:

- ✔ This worldwide standard provides a uniform interface and data exchange format that ensures compatibility even with third party manufacturers
- ✔ Plug and Play between machine, tractor and additional ISOBUS implements





Perfectly developed machine operation from AMAZONE

AMAZONE machinery and operator terminals offer a range of functions which are very easy and safe to operate:

- ✔ Highest compatibility and function flexibility of your ISOBUS equipment
- ✔ No additional modules on the machine side. All ISOBUS machines from AMAZONE come ready-equipped with the necessary ISOBUS functions as standard
- ✔ Practice-oriented machine software and logical menu structure
- ✔ MiniView display with all AMAZONE terminals and additional ISOBUS terminals. See, for instance, the machine data in the map view
- ✔ Possibility of operating the machine via the tractor terminal or a twin terminal solution
- ✔ Flexible assignment of the map and machine view between the tractor terminal and the operator terminal
- ✔ Unique operating concept. Freely configurable displays and individual user interfaces for each driver
- ✔ Functions such as HeadlandControl and parabolic part-width section control
- ✔ Integrated TaskController data logger function



Clearly-structured AMAZONE machine operation

Advantages of the AMAZONE machine software:

- ✔ User-oriented and intuitive
- ✔ Tailored to the machine
- ✔ Function scope above and beyond the ISOBUS standard

Automatic GPS-Switch part-area shut-off with Section Control

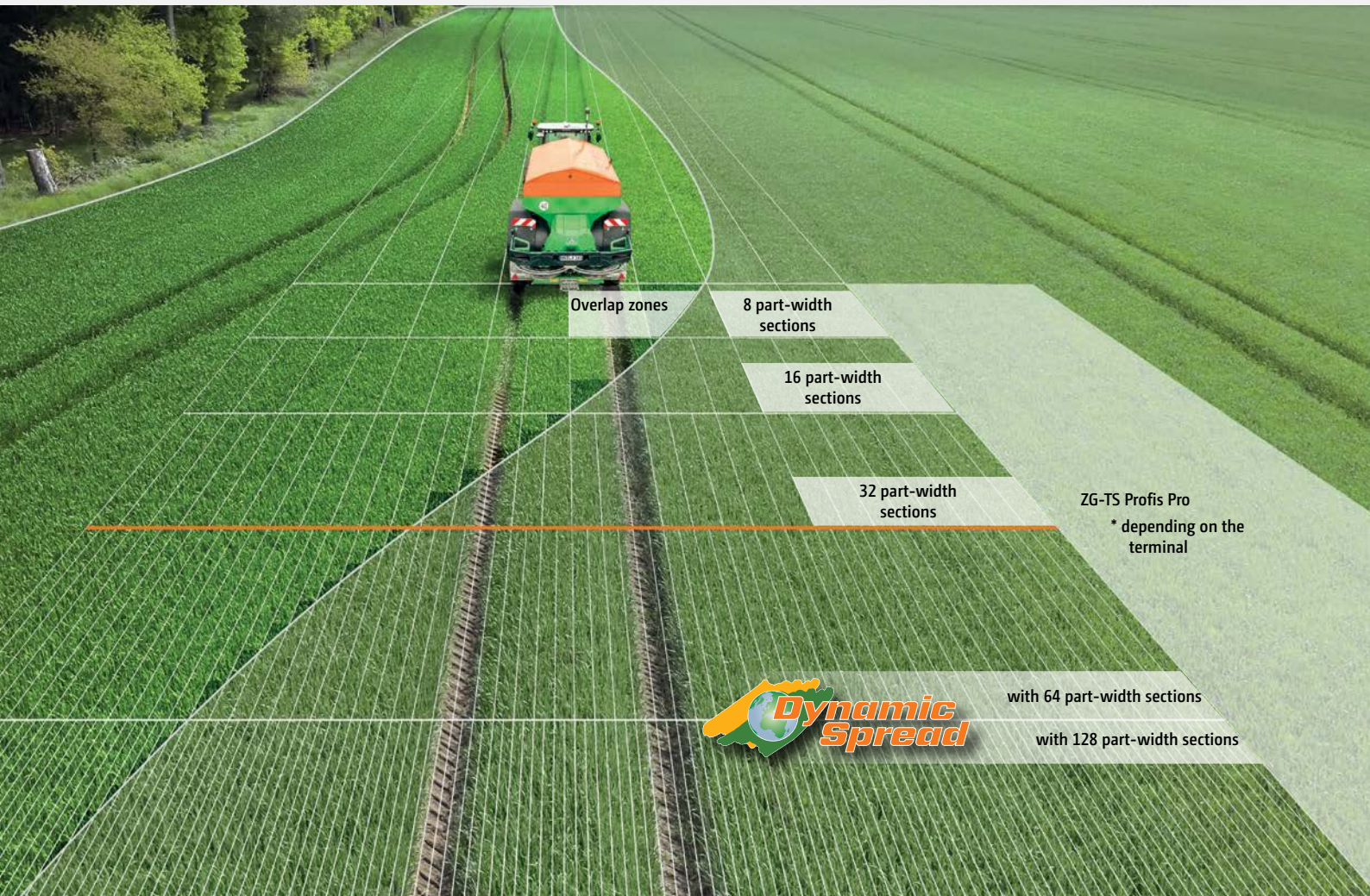

✔ With DynamicSpread, individual outlying part-width sections can also be controlled.

More precision, more efficiency!

In view of the very large working widths used now, the matching of the spread patterns is very important. Thanks to the electric delivery system adjustment on the TS spreading system, it is able to react precisely and sensitively in these cases. So even outer part-width sections can be easily controlled. In addition, due to the individual speed adjustment of the left and right hand side discs, the spreading width can be reduced from the far outside

to the centre, so that, even at large working widths, long and shallow-shaped wedges and short work are optimally spread. This means part-width section control. At the simplest level of specification, 8 part-width sections can be easily actuated manually (via the operator terminal). When utilising a relevant Section Control licence on the terminal, a part-width section control of up to a maximum of 128 part width sections can be utilised.

ISOBUS fertiliser spreader functionality	ZG-TS
	Electronic delivery system adjustment
Spread rate regulation	✓
Setting the delivery system	✓
Matching the spreading disc speed	✓
Number of part-width sections	8 in manual mode
<ul style="list-style-type: none"> • Manual mode at the press of a button • Automatic mode via SectionControl/GPS-Switch 	up to 128 in automatic mode
Possible working widths	15–54 m

If the operating terminal facilitates Section Control, such as GPS-Switch part-width section control from AMAZONE, the part-width sections are activated completely automatically and in relation to the GPS position. Once a field has been created, and then in automatic mode, the driver can concentrate fully on the operation of the towing vehicle, since the part-width sections are switched automatically in wedge shaped fields and on headlands.

Benefits of automatic part-width section control:

- ✓ Stress relief on the driver
- ✓ Increase in precision especially at night or at higher speeds
- ✓ Fewer overlaps and gaps
- ✓ Saving on input costs
- ✓ Less crop damage and less environmental pollution
- ❗ “With Section Control, the ISOBUS terminal takes a lot of pressure away from the driver.”
 (“dlz agrar magazine” – test report ZA-TS fertiliser spreader · 02/2017)

GPS-Switch

With GPS-Switch, AMAZONE offers GPS-based, fully automatic, part-width section control for all AMAZONE operator terminals and ISOBUS-compatible fertiliser spreaders, crop protection sprayers or seed drills.

GPS-Switch basic

- ✓ Automatic part-width section control for up to 16 part-width sections
- ✓ Creation of a virtual headland
- ✓ Parabolic part-width section control in the form of the spread fan
- ✓ Optional with AmaTron 4

GPS-Switch pro (as an add-on to GPS-Switch basic)

- ✓ Automatic part-width section control for spreaders with hydraulic spreading disc drive
- ✓ Marking of obstacles (e.g. water holes, pylons)
- ✓ Auto-zoom when approaching the headland

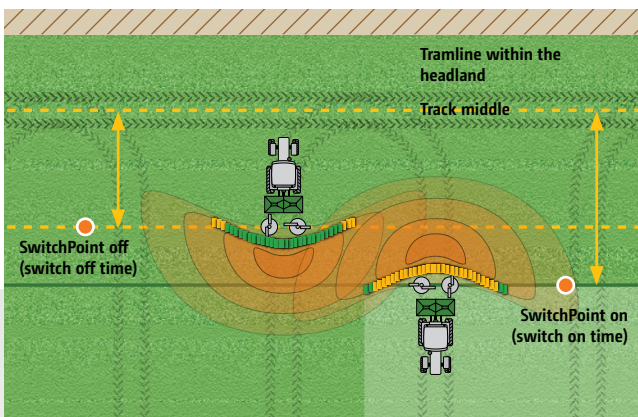

- ✓ When utilising GPS-Switch, SwitchPoint allows the on/off switching points to be re-adjusted depending on the fertiliser type and the working width.

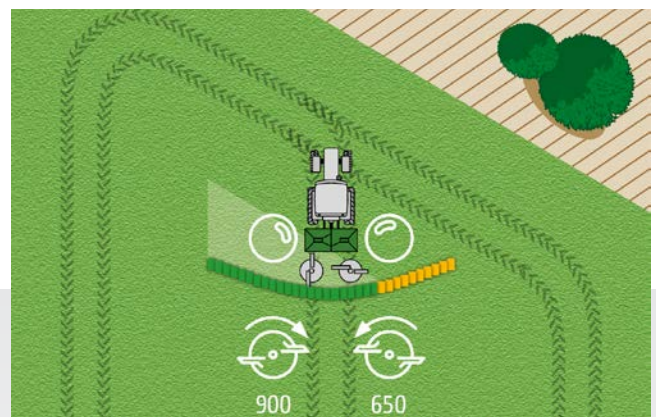

- ✓ Optimum part-width section control with adjustment of the delivery system, adaptation of the spreading disc speed (Hydro) and spread rate regulation.

Workday made easy –

Make the most of the possibilities!

GPS-Maps&Doc

All standard ISOBUS terminals from AMAZONE can collect and save machine and site-specific data using Task Controller. Part-area, site-specific operation via application maps in either Shape file or ISO-XML formats is also possible.

- ✔ Easy creation, loading and processing of jobs
- ✔ Start a new task straight away and decide later whether the data is to be saved or not
- ✔ Import and export jobs in ISO-XML format
- ✔ Job summary via PDF export
- ✔ Intuitive system for processing application maps in either Shape file format and ISO-XML format
- ✔ Automatic part-area, site specific regulation of the application rate
- ✔ Indication of inactive field boundaries and automatic field detection when approaching the vicinity
- ✔ Optimum crop management via needs-based application
- ✔ Available as standard with AmaTron 4

GPS-Track

The GPS-Track parallel guidance greatly helps with orientation in the field, especially on grassland or in areas without tramlines.

- ✔ With a virtual light bar in the status bar
- ✔ Automatic tramline control via GPS for seed drills
- ✔ Various track modes such as A-B lines or contour following
- ✔ Optional with AmaTron 4

AmaCam

Software licence for displaying a camera image on AmaTron 4.

- ✔ Automatic display of the camera image on AmaTron 4 when reversing



Display of the application map in AmaTron 4



Display of the camera image in AmaTron 4

AmaTron 4

Manager 4 all



Simple and convenient operation as intuitive as your tablet

Why not handle a terminal as intuitively as a tablet or a smartphone? With this in mind, AMAZONE has developed the operator-friendly AmaTron 4 which offers a noticeably smoother operational procedure, especially when it comes to job management. The AmaTron 4, with its 8" multi-touch colour display meets the highest expectations and offers maximum user-friendliness. A swipe of the finger or use of the App carousel allows quick changes between applications and the simple and clearly structured operating menu. A useful MiniView, a freely configurable status bar as well as a virtual light bar make the use of the AmaTron 4 particularly clear and convenient.

Benefits of AmaTron 4:

- ✔ Automatic full screen mode when not being touched
- ✔ Automatic display of the touch buttons via a proximity sensor
- ✔ Practical MiniView concept
- ✔ Actuation via the multi-touch colour display or soft keys
- ✔ Particularly intuitive and user-friendly
- ✔ Field-related documentation
- ✔ Practice-oriented and intelligent menu navigation
- ✔ Practical quick-start menu with import and export of job data, help windows, day/night mode and the AUX-N assignment
- ✔ One camera input and automatic reversing detection
- ✔ Free trial period for all chargeable licences
- ✔ AmaTron Connect – for the optional entry into the digital age

Equipped as standard with:

GPS-Maps&Doc



AmaPilot+ – everything in the one hand!

Thanks to the AUX-N feature, you can operate multiple functions on the machine via AmaPilot+ or any other ISOBUS multi-function joysticks.

Advantages of AmaPilot+:

- ✔ Nearly every function is controlled directly via the 3 levels
- ✔ Adjustable palm rest
- ✔ Freely programmable, individual key layout

AmaTron Connect

New ways of comfortable networked operation

With AmaTron Connect, AMAZONE provides a digital interface to a smartphone or tablet. The mobile device and AmaTron 4 are simply connected as a hotspot. AmaTron Connect enables use of the AmaTron Twin App as well as data exchange via agrirouter and the myAmaRouter App.

AmaTron Twin App Clear display enhancement

The AmaTron Twin App offers the driver even more comfort during work, as any GPS functions in the map view can also be operated via a mobile device, e.g. a tablet, in parallel with machine operation on the AmaTron 4.

Now download the free App and try the DEMO in the App.



Alternative map views with AmaTron Twin – clear display of the machine and its part-width sections, as well as buttons on the right hand side of the mobile device.



Everything in view at all times with the AmaTron Twin App and the holder kit for a tablet for rigid mounting on the AmaTron 4

Advantages of the AmaTron Twin display enhancement:

- ✔ Use of an existing mobile device
- ✔ Greater clarity – every application always in view
- ✔ Comfortable control of the GPS functions in the map view, in parallel, via the mobile device
- ✔ Clear, authentic representation of the working machine and its part-width sections

agrirouter –

the independent data exchange platform for agriculture



Watch the video for more details

Secure data exchange

agrirouter is an independent data exchange platform for farmers and contractors. It enables simple and cross-manufacturer data exchange between machines and agricultural software applications, thereby reducing administration. The user retains full control over the data at all times.

myAmaRouter App

For the on-line transfer of data between AmaTron 4 and agrirouter

The myAmaRouter App enables data to be exchanged between the AmaTron 4 ISOBUS operator terminal and the agrirouter manufacturer-independent data exchange platform. If an AMAZONE machine is to be used to carry out a task with job data (e.g. application maps), the data can be easily transmitted from a Farm Management Information System (FMIS) to AmaTron 4 via agrirouter and the myAmaRouter App. After the work has been completed, the job can be sent back and is available for documentation in an agricultural software application.

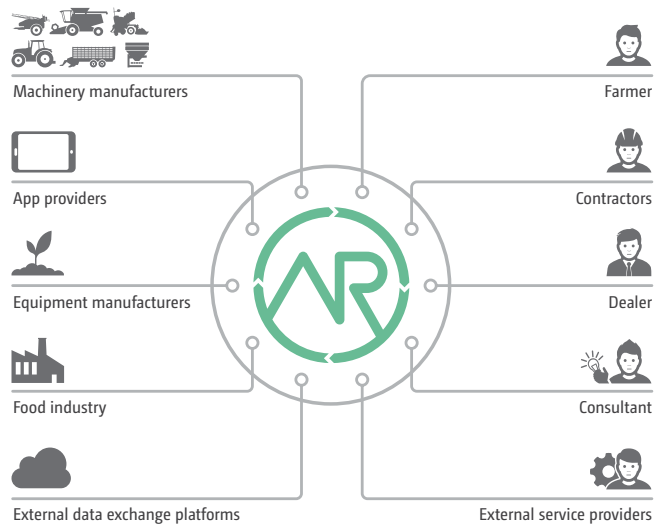

The manufacturer-independent agrirouter enables secure and uncomplicated data exchange.

Benefits of agrirouter:

- ✔ Simple data exchange between the AmaTron 4 ISOBUS operator terminal and the manufacturer-independent agrirouter data exchange platform
- ✔ Easy and rapid transfer of job and task data without the need for a USB stick
- ✔ More flexibility in data exchange and documentation

Uncomplicated data transfer. Transparent and secure!



ZG-TS 7501

Exclusive!

GPS ScenarioControl

Terminal software for the automation of complex switching processes



GPS ScenarioControl can be used in conjunction with the AmaTron 4 ISOBUS operator terminal and the AmaTron Twin App.

- ! "GPS-ScenarioControl from AMAZONE helps to prevent errors in the selection of the border spreading mode and any unnecessary wheel tracks."

("profi" – Practice test "Pushing boundaries with the App" · 01/2022)



GPS ScenarioControl view on the AmaTron Twin App



Field with complete route planning and saved, geo-referenced scenarios

Support for needs-based fertilisation

When applying fertiliser, drivers have to juggle various tasks. Firstly, they need to ensure optimal lateral distribution of the material to be spread, as well as maintaining the desired application rate of the fertiliser. Secondly, they must ensure that the most appropriate border spreading mode is used alongside ditches, footpaths or field boundaries, to guarantee legally compliant and precise fertilisation. This can lead to operator errors, especially when changing drivers, as the right border spreading procedure is not activated or deactivated in the right place. Lack of driver knowledge can also lead to non-compliance when applying fertilisers.

Record and store the right driving strategy

When crossing the field for the first time with the fertiliser spreader, all the switching points, driving route and driving direction can be automatically plotted by an experienced driver using GPS ScenarioControl, by pushing the record button. The switching points are clearly marked on the map and the driving direction is visualised with arrows. GPS ScenarioControl is integrated in the AmaTron 4 ISOBUS operator terminal and can be viewed and operated via the AmaTron Twin display extension.

Automation of complex switching processes and reduction of driver workload

In the following application, the driver only needs to activate the previously plotted scenario and the fertiliser spreader will automatically perform the saved switching processes. GPS ScenarioControl enables the precise, resource-efficient use of fertiliser, as the various spreading procedures are performed in exactly the right places. This ensures that any subsequent applications by other drivers are legally compliant. In addition, drivers can use the pre-plotted, optimised field route as a guide.

The advantages at a glance:

- ✔ Always the same switching processes with different fertiliser applications
 - Prevention of operator error
 - Legally compliant and resource-efficient fertiliser application guaranteed
 - Correct application in poor visibility, e.g. darkness or fog
- ✔ No flattening of crops because routes in the field are always optimised
 - Supports inexperienced drivers

❗ "As a result, the tool provides farm managers with the assurance that their drivers apply the fertiliser beside ditches and paths within the law and elsewhere are optimised for yield. This is particularly interesting when the drivers frequently change or when the boss wants to entrust the fertilisation to, for instance, his trainees."

("prof" – Practice test "Pushing boundaries with the App" · 01/2022)

ZG-B trailed spreader



10 m – 36 m



5,500 l and 8,200 l



1 to 2 part-width sections



Fertiliser, pelleted fertilisers,
lime

The advantages at a glance:

- ⊕ The robust universal twin disc spreading unit with oil immersed gearbox and overload safety device allows the application of mineral fertiliser, lime or other earth-moist fertilisers
- ⊕ Rigid and robust chassis technology, designed for speeds of up to 50 km/h
- ⊕ Large ground clearance and oversized tyres allow operation even under the most difficult of conditions
- ⊕ The large fill opening ensures easy filling procedures from bulk silos or with a front-end loader
- ⊕ The steep hopper walls ensure the consistent flow of the spreading material even in sloping terrain
- ⊕ Low-wear rubber floor belt with automatic floor belt centring

MORE INFORMATION

www.amazone.net/zg-b



PRODUCT FILM
Find out more



DOWNLOADS
mySpreader App



SMARTLEARNING
www.amazone.net/smartlearning

ZG-B bulk fertiliser spreaders

With universal spreading unit for fertiliser and lime



ZG-B Super 8200

With the ZG-B hopper volumes of 5,500 l and 8,200 l, AMAZONE introduces high capacity trailed spreaders for the economic and ecologic application of mineral fertilisers and earth-moist fertilisers. Thanks to their reliability and easy handling, the ZG-B's are perfectly suited for operation on large farms, with contractors or in farm overlapping situations. Various specification options and a comprehensive range of special equipment make the ZG-B the individual all-rounder for all fertiliser tasks.

Running gear – high levels of comfort for maximum work rates

- ✔ Rigid and robust chassis technology, designed for speeds of up to 50 km/h
- ✔ Over-size tyres reduce ground contact pressure and enable the spreader to be used in even the harshest of conditions
- ✔ 7.0 to 9.8 t payload
- ✔ Track widths of 1.50 to 2.25 m are possible for tyres with an AS profile
- ✔ Increased driving comfort due to spring-suspended and height-adjustable drawbar systems
- ✔ Increased safety in road traffic due to large-dimensioned axles and brakes (Twin-circuit air braking system or hydraulic braking system)
- ✔ High ground clearance

Further optional benefits:

- ✔ Remote-control of side and boundary spreading possible
- ✔ Precise fertiliser metering using state-of-the-art weighing systems

- ✔ Standard comfort: the automatic rubber belt floor control guarantees constant conveyor centring, even under demanding conditions.

Large-capacity hopper – saves travelling and loading time

- ✔ Easy to fill from the store or using a loader thanks to large filling opening.
- ✔ Steep hopper walls ensure a consistent flow of spreading material even on sloping terrain
- ✔ Low-wear rubber floor belt with automatic floor belt control

Sophisticated technology – first-class spreading results

- ✔ Stainless steel sheet metal withstands even intense abrasion from fertilisers
- ✔ Mechanical spreading disc drive available for PTO shaft speeds of 540 rpm, 720 rpm or 1,000 rpm
- ✔ Maintenance-free and robust oil-bath gearbox with integrated overload safety



ZG-B Special and ZG-B Super –

Cutting costs with high performance!



ZG-B Special

- ✔ Mechanical spreading disc drive
- ✔ Floor belt drive via PTO shaft
- ✔ Hopper volume 5,500 / 8,200 l
- ✔ Working widths 10–36 m



ZG-B Super

- ✔ Mechanical spreading disc drive
- ✔ Belt floor drive via ground wheel (forward speed-related application rate regulation)
- ✔ Hopper volume 5,500 / 8,200 l
- ✔ Working widths 10–36 m

- ✔ The ZG-B Super features forward-speed related rate control via ground wheel drive. The ground wheel drive ensures that the spread rate remains constant even at different forward speeds.
- ✔ Via the gearbox (ZG-B Special / ZG-B Super) there is a choice between two floor belt speeds for metering either large or small application rates.



Robust and reliable

The robust ZG-B Special and ZG-B Super bulk fertiliser spreaders are top of the class when it comes to cost-effective fertilising. They are equipped with a strong universal lime spreading unit for working widths of up to 15 metres. This enables even large quantities to be evenly and accurately distributed.

Versatile

In addition, the ZG-B Special and ZG-B Super bulk material spreaders can also be equipped with the OM spreading discs allowing the spreading of mineral fertiliser at working widths of up to 36 m. Changing the spreading discs is very simple and quick.



Stainless steel rate sluice gate for setting the spread rate with an easily readable scale directly in the operator's field of vision, and easily adjustable.

Optional: hydraulic actuation and half-side shut-off with the double shutter slide system.

The rugged universal twin-disc spreading unit with oil-bath gearbox and overload safety for direct driving of the spreading discs ensures an even distribution, even with very high spread rates.

Also available as an option: OM spreading discs for the application of granular mineral fertiliser.

AMAZONE spreading technology – absolute accuracy



Exact: the OM spreading discs with adjustable spreading vanes provide a spread pattern of the utmost precision.

Simple: the working width and spread rate can be easily set using spreading vanes and metering shutters without the use of tools.

Durable: OM spreading discs are made completely of high-grade stainless steel and are simple to install.

Extra: with OM spreading discs, you also have the ideal equipment for late top dressing. Simply fold up the swivel blades supplied as standard on the spreading vanes.



OM spreading discs for ZG-B:

OM 10-16

OM 18-24

OM 24-36 (with hard-faced coating for a long service life)

Keeping it green!

AMAZONE Limiter border spreading system

Limiter made from stainless steel

Side and boundary spreading are among the most important aspects of fertiliser spreading. The AMAZONE Limiter enables precise application of fertiliser right up to the edge of the field. It ensures optimal distribution and excludes over-spreading in areas that are not used for agricultural purposes. This is not only particularly economical, but also provides active environmental protection. The hydraulically-actuated Limiter is controlled comfortably and directly from the tractor seat.

The Limiter can be moved on a fixed frame within a generously dimensioned swivel range. This enables easy adjustment according to the function required (working width, side or boundary spreading, type of fertiliser).

The benefits:

- ✔ Non-stop spreading
- ✔ No interruption of work
- ✔ No climbing down from the tractor

Limiter in action

The Limiter is swung down into the spread fan. The lamellar block creates a change of direction for part of the fertiliser fan.

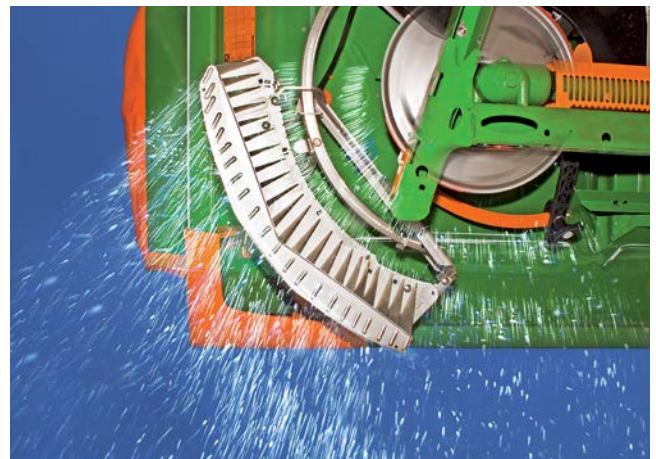

The result:
an optimal spread fan along the boundary.



Limiter border spreading system in working position



Limiter border spreading system raised out of work

Additional options also available



The swivelable hopper cover protects the fertiliser against mud and rain.



Hydraulic shutters enable you to switch off each side individually, e.g. base fertilising. For spreading earth moist lime, dried chicken manure, dehydrated sewage sludge, etc., you can simply wind up the shutter and if necessary, lower the chain rake.



Specialist equipment: Spreading disc for bone meal complete with chain rake for an even material flow.



The large hopper capacity means that filling times are reduced to a minimum. This enables a significant increase in the area output per working hour.



With the calibration kit, the flow rate of the fertiliser is checked. This means that the application rate can be accurately determined.



Via the weighing system, the hopper fill level and the application rate is always in view.



40 km/h approved:
Large warning signs and robust mudguards.



Plastic transport box offers a convenient way to transport the mobile test rig.



Robust guide chute – for use with granulated fertilisers in conjunction with the OM spreading discs (ZG-B Special, ZG-B Super).



The reversing camera offers additional safety when manoeuvring about the yard or in the field. The camera also offers night vision and a heated lens for maximum visibility.



Weighing display without regulation for monitoring the hopper contents (only for ZG-B Special & ZG-B Super). The maximum transport speed in combination with the weighing system is limited to 40 km/h.



Large protective sieves – the spreading system is optimally protected from stones or other foreign objects.

Spreader Application Center

Exemplary – for more than 25 years

The settings are crucial!

AMAZONE is providing even better customer service with the Spreader Application Centre. In addition to the already well-established fertiliser laboratory and spreading hall, the Spreader Application Centre now also includes the areas of “Test and Training”, “Data management” and the associated “Knowledge transfer”.

The last two areas are accompanied by a restructuring to address the increasing globalisation and digitalisation of agriculture. The aim of the Spreader Application Centre is to offer to the customer an even better service with regard to fertiliser application.



Fertiliser laboratory



Spreading hall



Test and Training

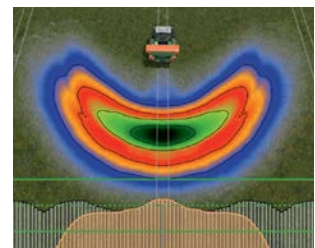

Data management and knowledge transfer

Only when properly spread is your fertiliser worth its weight in gold

The AMAZONE FertiliserService closely cooperates with well-known manufacturers of spreading material – worldwide - to be able to make available to you the best setting results as quickly as possible. AMAZONE is the name for precise spreading charts, worldwide.

FertiliserService – You can contact us via:

The FertiliserService works across borders, but not only geographically. This is because no matter whether your fertiliser spreader is 1 or 50 years old, we are always by your side with competent and reliable assistance.



Modern fertiliser spreader testing hall

Internet: www.amazone.net
 E-Mail: duengeservice@amazone.de
 Telephone: +49 (0)5405 501-111
 WhatsApp: +49 (0)175-488 9573

AMAZONE fertiliser spreaders can be optimally set up using the free **mySpreader App**:



mySpreader App

The all-in-one package for perfect spreader adjustment



EasyCheck is an integral part of the mySpreader App

FertiliserService, EasyCheck & EasyMix

The mySpreader App bundles all the App functions for Amazone fertiliser spreaders into the one App. The intuitive operation and convenient adjustment of the fertiliser spreader lies at the heart of the all-in concept.

FertiliserService

The FertiliserService App conveniently generates precise adjustment recommendations directly in the field, depending on the model of spreader, working width, fertiliser type and application rate. Thanks to the many samples sent in annually by farmers, fertiliser suppliers and fertiliser manufacturers, the App is constantly kept up-to-date so that the end user has access to current information at the start of every season. A special feature of the mySpreader App: the operator can search for fertilisers by entering the fertiliser name, the chemical composition, the granule size or bulk density, for example.

EasyCheck

The second element of the mySpreader App is the digital and mobile EasyCheck test kit. In this test kit, plastic mats are simply placed in the field at defined intervals, spread

over and then photographed. EasyCheck then calculates the degree of coverage of each mat. Based on these values, the App suggests improved settings for the lateral distribution of that fertiliser through the Amazone spreader, allowing the operator to rapidly optimise the accuracy of their crop care.

EasyMix

The mySpreader App is rounded off by the EasyMix App, which works out setting recommendations for blended fertilisers. Different fertilisers are often mixed together to save on the number of applications and so reduce operating costs. This is usually a nutrient-based fertiliser application. However, if the constituents in the blend have different physical properties, precise placement becomes increasingly difficult, especially at increasing working widths. EasyMix determines the best possible compromise between different constituents and suggests the optimal setting values for the ZA-TS and ZG-TS spreaders.

All the settings for the spreader can be transferred from the mySpreader App to the AMAZONE fertiliser spreader via a Bluetooth adapter. This saves time and avoids setting errors, whilst, at the same time, being much more convenient.



AMAZONE – always in your vicinity

Your satisfaction is our challenge



The satisfaction of our customers is the most important objective

We rely on our nationwide network of expert, committed sales partners to achieve this. Also for service queries they are the reliable contact partner for farmers and contractors. Due to continuous training, our sales partners and service technicians are always up to date when it comes to looking after our state-of-the-art technology.

We provide you with a first-class spare parts service

The spare parts centre in Tecklenburg-Leeden is the base for our worldwide spare parts logistics system. This ensures optimum availability of spare parts, even for older machines.

Orders for parts in stock at the Tecklenburg-Leeden spare parts centre which, if placed by 5 p.m., leave our premises the same day. 42,000 different spare parts and wearing metal parts are handled and stored via our modern warehousing system. Up to 1,000 orders are sent out to customers every day.



Better to choose the original right from the start

Your machines are subjected to extreme use! The quality of AMAZONE spare parts and wearing metal offers you the reliability and security you need for efficient soil tillage, precise sowing, professional fertilisation and successful crop protection.

Only original spare parts and wearing metal parts provide the durability and functionality expected from AMAZONE machinery. This guarantees an optimum quality of work. Original parts at fair prices pay for themselves in the end.

So opt for the original!

The advantages of original spare parts and wearing metal parts

- ✔ Quality and reliability
- ✔ Innovation and efficiency
- ✔ Immediate availability
- ✔ Higher resale value of the used machine



SmartLearning – Interactive driver training on the App or on a computer

With the “SmartLearning” tool as an App on your smart-phone, on-line or as a download version for your computer, AMAZONE offers a useful function to make it easier for you to work efficiently with our machinery and terminals.

“SmartLearning” is an interactive training programme which gives drivers the opportunity to familiarise themselves with the operation of the machine before using it for the first time. However, experienced drivers can also refresh their knowledge here, in order to make even better use of the potential performance of their machine.

Via our homepage as an on-line version for for download:
www.amazone.net/smartlearning

Or as an App
on your smartphone:

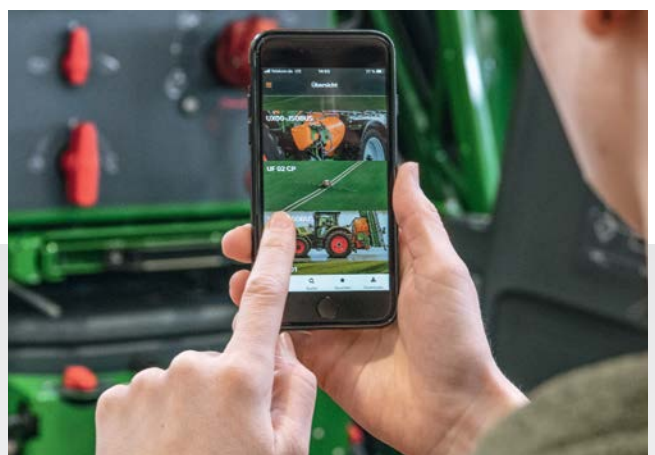

Technical data

ZG-TS trailed spreaders

Model	ZG-TS 7501 ProfisPro	ZG-TS 10001 ProfisPro
Working width (m)	15–54	
Hopper capacity (l)	7,500	10,000
Permissible total weight (kg)	12,500	12,500
Max. payload (kg)	8,650	8,500
Filling height (m) + static tyre radius	1.71	1.98
Filling width (m)	4.09	
Filling depth (m)	1.94	
Overall length (m)	7.33	
Total width (m), (depending on the tyres fitted)	2.48–2.90	
Total height (m), (depending on the tyres fitted)	2.68–3.03	2.95–3.30
Spreading disc drive options	Hydraulic-drive with oil supplied exclusively from the tractor: Oil requirement with steering axle max. 130 l/min Oil requirement without steering axle max. 105 l/min Hybrid drive with combined oil supply: Oil requirement with steering axle max. 85 l/min Oil requirement without steering axle max. 60 l/min	
Weighing system	ProfisPro c/w FlowControl torque measuring system	
Min. weight (kg) (without optional equipment)	3,850	4,000

Illustrations, content and technical data are not binding! Deviations of technical data are possible depending on the equipment. The illustrations may deviate from the requirements for local road traffic regulations.



ZG-B trailed spreaders

Model	ZG-B 5500	ZG-B 8200
Hopper capacity (l)	5,500	8,200
Unladen weight (kg)	2,500 – 3,500	
Permissible total weight (kg)	8,000 – 10,000	8,000 – 12,000
Payload on public roads (kg)	5,900 – 7,700	5,800 – 9,800
Filling width (m)	3.45	
Overall length (m)	6.70	
Total width (m), (depending on the tyres fitted)	2.26 – 2.75	
Total height (m), (depending on the tyres fitted)	2.26 – 3.10	

Illustrations, content and technical data are not binding! Deviations of technical data are possible depending on the equipment. The illustrations may deviate from the requirements for local road traffic regulations.





AMAZONE



AMAZONEN-WERKE H. DREYER SE & Co. KG
P. O. Box 51 · 49202 Hasbergen-Gaste/Germany
Phone +49 (0)5405 501-0 · Fax +49 (0)5405 501-193